



# HERALD of HOLINESS

CHURCH OF THE NAZARENE / OCTOBER 15, 1981

## AN EDITORIAL

**T**HE SUMMER has ended in our northern hemisphere. The sun appears lower on the horizon, makes its appearance later in the mornings and makes a hurried exit in the evenings. Nature is exchanging its bright summer colors for the more subdued colors of its winter moods. In our American Midwest the great combines are busy gathering the harvest of wheat and corn and other life-giving foods necessary to sustain life on the earth.

In the southern hemisphere the gentle winter mood is changing to summer, and nature responds to the warmth of the summer sun and rain. To those living in this hemisphere it is a time of sowing and planting.

Although the time element differs, the universal mood at harvesttime is one of gratitude. Christians throughout the world pause to give thanks to God for the harvest the good earth has yielded. America observes Thanksgiving Day the last Thursday in November. Canada observes Thanksgiving the second Monday in October. Other countries observe a harvest festival. In

most areas there is some manifestation which expresses gratitude to God for His bountiful mercies.

There is abundant evidence that the spiritual harvest of the world must now be gathered. Revivals being reported, church growth in world areas, new doors becoming open, responses to the gospel—all give evidence that the “fields are white unto harvest.” The unrest and frustration which is universal, together with crime and rebellion so apparent everywhere, give a new sense of urgency to proclaim Christ as the answer.

The American Thanksgiving season has been adopted as a time to give expression of gratitude to God by giving a worldwide missionary offering for world evangelization. In recent years this great offering has enabled the church to continue its advance into world areas despite the changing financial values and high costs of living encountered by missionaries living abroad. Within a few weeks we will bring our offering of thanksgiving to make possible the ingathering of the world’s spiritual harvest. May all of us give good accountability to God from a thankful heart. □

# THE WORLD HARVEST

“CHRISTIANS THROUGHOUT THE WORLD PAUSE TO GIVE THANKS TO GOD . . .”



by General Superintendent Charles H. Strickland

# Where'er the SUN

by SUSAN JENKINS

I THOUGHT I recognized the familiar strains. Turning to my friends, I whispered, "Do you know what they're singing?"

Without waiting for an answer, I sang softly,  
*I am so glad that our Father in heav'n  
Tells of His love in the Book He has giv'n.  
Wonderful things in the Bible I see;  
This is the dearest, that Jesus loves me.*

How sweet that sounds, Lord! How can they even sing these words? Oh, how often I have taken them for granted, sung without *thinking!*

It was hot as we made our way through the crowd which pressed in all around us. It had been a week since we entered the People's Republic of China. We had visited cold, damp tombs and had admired ancient palaces. We had climbed the Great Wall and had studied their magnificent past. We had bought lovely silk clothing and delicate tea sets, exchanged addresses with hundreds of people, visited inadequate hospitals, ate gourmet meals and read Mao Tse-Tung messages everywhere.

We had fallen in love with these people. All dressed alike, they roamed the streets in their white shirts, baggy pants, and flat shoes. With childlike curiosity, they giggled at the spectacle of our American expressions and animation. Catching our eyes, they would look down or glance away, then back again. If we smiled, they would shyly move closer to try out their English, touch our clothes, and give us their babies to hold—with or without diapers!

A hungry young man had quietly asked, "Do you have a Bible?"

I looked into his intent face, and fingering the Chinese Bible in my bag, had to reply, "I know of someone who will send you one. Let me have your address."

We had been instructed not to trust anyone with our precious cargo.

Remembering to pray with open eyes, we trusted Jesus Christ to provide ways to share His love without endangering the already-threatened Christians in China.

Now I could barely contain my joy—in this rare "open" church—as I sensed the freedom we finally had . . . in Jesus Christ. The blank, expressionless faces were now smiling, nodding to us, and filled with the wonder of Christ's love. They touched our hands,

SUSAN JENKINS is a public school teacher in Livermore, California.

ABS Photo



Front cover of the New Testament in Today's Chinese Version, recently published by the United Bible Societies. The Chinese word for *gospel* means literally "Blessed News," thus the cover design features 100 calligraphic variations of the Chinese character for the word "blessing." It is the first new Chinese translation published by the Bible Societies since 1919.

with tears in their eyes and on our faces. From our balcony seats, we watched in amazement as hundreds of people struggled to see one of the few Bibles scattered throughout the congregation. The Holy Spirit moved mightily among all of us, overcoming language barriers and political differences. Sweat mingled with our tears. We rejoiced, praising God for the oneness we shared in Him.

How many of these people have quietly sought You, Lord, all through these dark, isolated years? How many pastors will continue to be courageous enough to risk their lives for You?

It has been seven months since I went to church in Shanghai. Yesterday, our 50-voice choir sang *Jesus Shall Reign* from our brand-new hymnals in our comfortable sanctuary with the morning sun streaming in through the picture window.

The words rang out,

*People and realms of ev'ry tongue  
Dwell on His love with sweetest song.*

Grey China . . . rain . . . humidity . . . sweat . . . people squeezed together everywhere . . . sadness . . . *sameness* . . . heaviness . . . worshiping in a dark church along with pictures of Lenin, Stalin, and Marx.

The organ swelled and the harmony rose,  
*Jesus shall reign where'er the sun  
Does his successive journeys run;  
His kingdom spread from shore to shore,  
Till moons shall wax and wane no more.*

Chinese Christians dwelling on Your love with the very sweetest of songs . . . overcoming communism, war, threats . . . Lord, I know that You can overcome those . . . but here are my relationships, schedules . . . oh, the pressures of *living well* are so great . . . I need you here . . .

*Jesus shall reign where'er the sun . . .*

Right here, in the middle of our humanity, in our beautiful, tense lives . . . in dark, crowded China . . . break through, Lord!

His love is gently moving in . . . *wher'er the sun . . .*

□



# HERALD of HOLINESS

W. E. McCUMBER, Editor in Chief  
IVAN A. BEALS, Office Editor  
MABEL ADAMSON, Editorial Assistant

Contributing Editors: V. H. LEWIS • ORVILLE W. JENKINS  
CHARLES H. STRICKLAND • EUGENE L. STOWE  
WILLIAM M. GREATHOUSE • JERALD D. JOHNSON  
General Superintendents, Church of the Nazarene

Cover Photo: by Russ Hansen.

Volume 70, Number 20 October 15, 1981 Whole Number 3336

### Bible Quotations in this issue:

Unidentified quotations are from the KJV. Quotations from the following translations are used by permission:

(RSV) From the Revised Standard Version of the Bible, copyrighted 1946, 1952. © 1971, 1973.

(NASB) From the New American Standard Bible, © The Lockman Foundation, 1960, 1962, 1968, 1971, 1972, 1973, 1975.

(NIV) From The Holy Bible, New International Version, copyright © 1978, by New York International Bible Society.

(Phillips) From the New Testament in Modern English, Revised Edition © J. B. Phillips 1958, 1960, 1972. By permission of the Macmillan Publishing Co., Inc.

HERALD OF HOLINESS (USPS 241-440) is published semi-monthly by the NAZARENE PUBLISHING HOUSE, 2923 TROOST AVE., KANSAS CITY, MO 64109. Editorial Office at 6401 The Paseo, Kansas City, MO 64131. Address all correspondence concerning subscriptions to Nazarene Publishing House, P.O. Box 527, Kansas City, MO 64141. CHANGE OF ADDRESS: Send us your new address, including ZIP code, as well as your old address, and enclose a label from a recent copy. SUBSCRIPTION PRICE: \$5.00 per year. Second class postage paid at Kansas City, Mo. Litho in U.S.A.

## IN THIS ISSUE

<b>THE WORLD HARVEST</b> .....	<b>2</b>	<b>MY REWARD</b> .....	<b>13</b>
<i>General Superintendent Charles H. Strickland</i>		<i>Poem</i>	<i>Alice Hansche Mortenson</i>
<b>"WHERE'ER THE SUN"</b> .....	<b>3</b>	<b>SPIRITUAL MALABSORPTION</b> .....	<b>14</b>
<i>Susan Jenkins</i>			<i>William L. Poteet</i>
<b>LETTERS</b> .....	<b>4</b>	<b>NAZARENE ROOTS: BIRTH OF THE CHURCH OF THE NAZARENE</b> .....	<b>15</b>
<b>BEHOLD I STAND—AND KNOCK</b> .....	<b>5</b>		
<i>Poem</i>	<i>John A. Wright</i>	<b>"WITHOUT THE BINGO PARTIES, WE'D NEVER MAKE IT"</b> .....	<b>16</b>
<b>"KEEP THYSELF PURE"</b> .....	<b>6</b>		<i>Lola M. Williams</i>
	<i>Albert J. Loun</i>	<b>COUNT YOUR PEARLS</b> .....	<b>17</b>
<b>FAMILY WORSHIP</b> .....	<b>7</b>	<i>Book Brief</i>	<i>Esther Lunsford</i>
	<i>Myron L. Tweed</i>	<b>GOD KNOWS</b> .....	<b>17</b>
<b>DEALING WITH THE TRIALS OF LIFE</b> .....	<b>8</b>	<i>Poem</i>	<i>Edna Moore Schultz</i>
<i>Helps to Holy Living</i>	<i>Bud Reedy</i>	<b>THE EDITOR'S STANDPOINT</b> .....	<b>18</b>
<b>THE COMFORTER</b> .....	<b>9</b>		<i>W. E. McCumber</i>
<i>Poem</i>	<i>Helen R. Sullivan</i>	<b>BY ALL MEANS</b> .....	<b>20</b>
<b>BETTER THAN IT HAS TO BE</b> .....	<b>10</b>	<i>The Power of Prayer</i>	<i>Ernie Gray</i>
	<i>Stan Meek</i>	<b>IN THE NEWS</b> .....	<b>21</b>
<b>THE MOCKER</b> .....	<b>11</b>	<b>NEWS OF RELIGION</b> .....	<b>30</b>
	<i>William Goodman</i>	<b>ANSWER CORNER</b> .....	<b>31</b>
<b>THE SABBATH AND ITS RELATIONSHIP TO MODERN TIMES</b> .....	<b>12</b>	<b>LATE NEWS</b> .....	<b>35</b>
	<i>Paul W. Beals</i>		



Letters for this column must be brief and in good taste. Unsigned letters will not be used, but names will be withheld upon request. Address your letter to Editor, "Herald of Holiness," 6401 The Paseo, Kansas City, MO 64131.

### PLUGS GOSPEL MUSIC

I do appreciate concern for music that has content and conviction. I do need to point out to the readers of this magazine that a high percentage of today's gospel music is solid, has content, and does not compromise the faith. In addition to being a Church of the Nazarene pastor, I am a gospel disc jockey for a local radio station. We receive all the new music from recording studios all over the country and I can report that we have many outstanding individuals and groups that are being used of God in a very important ministry, artists that are honest, Spirit-led, and instruments of God. Gospel music is still a very valuable avenue of ministry.

Finally, I agree that faith is more than "feeling," but praise God for the fact that I can feel it and for the "personal joy of the Christian life." Praise music is an extremely important part of the entire field of gospel music.

—Lance G. Bird  
Saco, Maine

### MUSIC IMPROVING

Concerning church music: There is indeed much "worldly" music being played and sung in some churches today. However, I believe that church music in general is improving. There is much good appropriate music, old and new, available today. What needs to be done, in many cases, is for our church people to first get their

musical priorities in order and then keep them there.

—Charles C. Davidson  
Brandon, Florida

### BABY DEATHS AND BUSINESS DOLLARS

Most evangelicals supported Reagan for president primarily because he promised to support a constitutional amendment to ban all abortions; this includes abortions where young girls have been impregnated by fathers, grandfathers, and brothers, and where women have become pregnant because of rape.

Manufacturers of baby formulas, one of the prime offenders being Nestle Company located in

(Continued on page 20)

**Nazarenes are EXPANDING their Mission to the World.  
Growth at home and abroad characterizes our church.**

**In order to meet the need  
our people once again are preparing to bring in a great  
Harvest offering on Thanksgiving Sunday, November 22.**

**A record goal has been set—  
\$7,500,000**

**The Board of General Superintendents challenges our church  
to express gratitude to God for His goodness to us by bringing in  
the largest Thanksgiving offering ever.**

**Jerald D. Johnson, Secretary, BOARD OF GENERAL SUPERINTENDENTS**

## ABOUT THE COVER

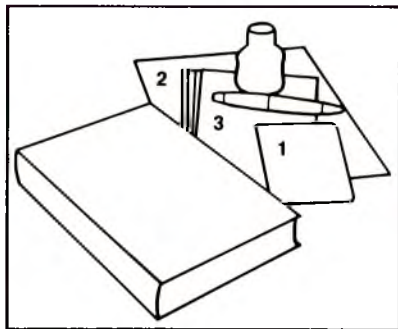

In anticipation of the church's 75th anniversary in 1983, Nazarene Publishing House announces the release of *Phineas F. Bresee: A Prince in Israel*. The book is a detailed biography of one of the church's founders, written by his colleague and personal friend, E. A. Girvin.

The author's training as a court reporter is evident in his crisp, lucid writing style and objectivity.

Out of print for 50 years, the handsomely bound volume is a reproduction of the original 1916 edition. It was the publisher's conviction that this generation of Nazarenes should know the record of Bresee's God-directed life and the roots of our denomination. This prompted the reprinting of *A Prince in Israel*.

Other interesting details in the cover photo are the following items taken from the archives:

- 1) Dr. P. F. Bresee's personal copy of the 1911 church *Manual*;
- 2) An autograph letter from Dr. Bresee to H. F. Reynolds, dated December, 1908.
- 3) A set of Dr. Bresee's sermon notes.

Steve Cooley, director of Archives, says the church collection of historical documents and artifacts is rich treasury for the church historian and for those who wish to better understand the heritage that is the foundation for the Church of the Nazarene.

The cover photograph is by Russ Hansen. □

## Behold I Stand—and Knock

*I heard You knock so softly, Lord,  
You wished to enter in.  
But I was busy with the world,  
Its pleasures and its sin.*

*Again You knocked so patiently,  
Though more insistent still.  
Again I turned my heart away,  
But it was sore and ill.*

*You knocked once more upon the  
door.*

*I opened it—just so.  
I didn't want to let You in,  
Nor yet to let You go.*

*Then finally in tender love,  
You knocked yet once again.  
'Twas then I knew I needed You,  
The truth broke, oh, so plain.*

*The latch inside, I opened wide  
The door for all to see,  
Confessed my sin and let You in,  
Oh! What a change in me!*

—JOHN A. WRIGHT  
*Weidman, Michigan*

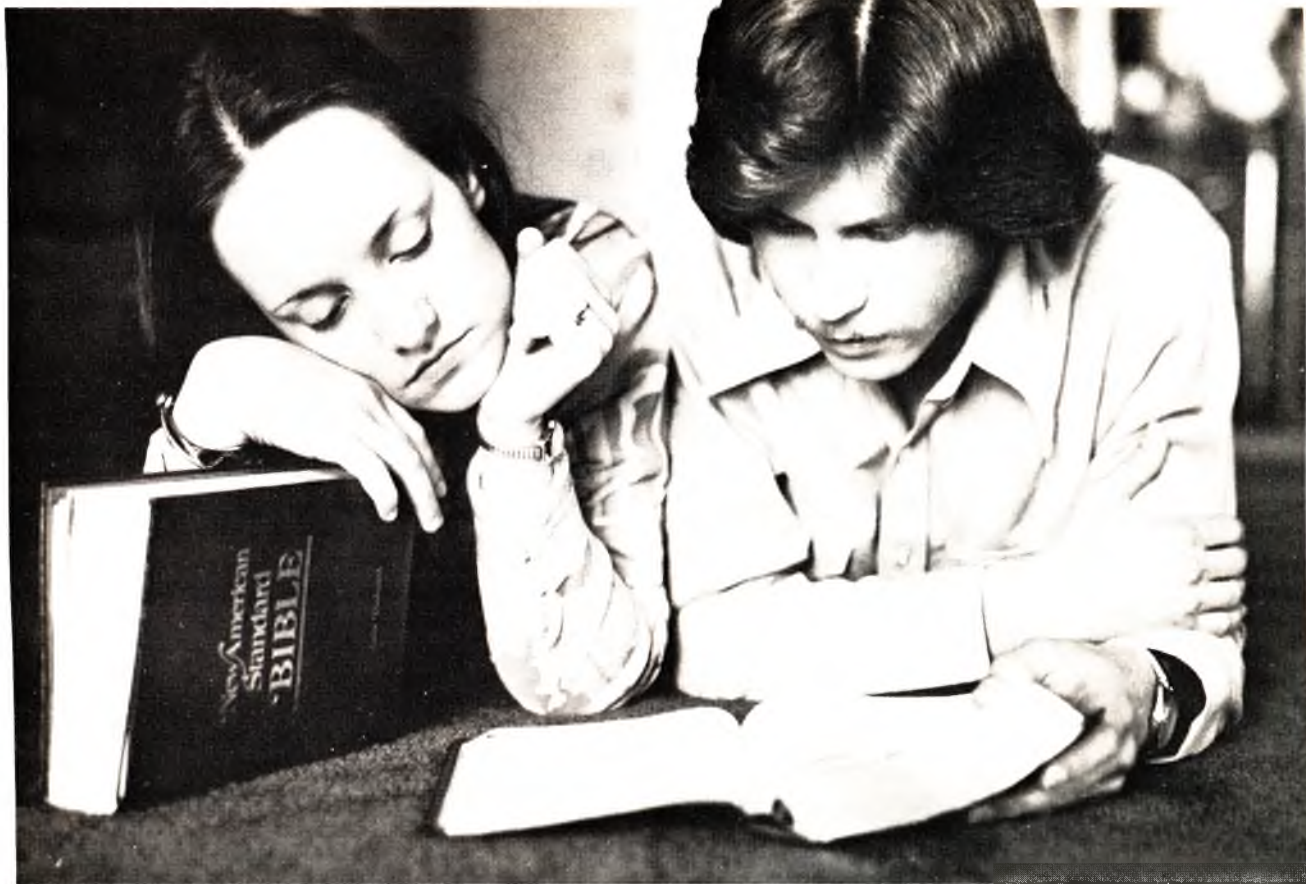

# “KEEP THYSELF PURE”

**K**EEP THYSELF PURE” (1 Timothy 5:22). Divorced from the New Testament message and grace of full and free salvation, Paul’s admonition confronted Timothy with an impossible task. Living in an impure world, conscious of the “earthen vessel” of a fallible human personality, and assailed by the fiery darts of the wicked one, even to a young pastor blessed with high ideals and apostolic fellowship, the exhortation would be cruel in the extreme if its realization was beyond attainment. Loving Timothy as his own son, Paul would never burden him with a hopeless quest.

The earnest plea presupposes God’s miracle of cleansing in heart and life, for no one can keep that which they do not possess. Nowhere in the New Testament is spiritual and moral purity viewed or expected as an unaided human achievement. Paul speaks for every man in Romans 7, when he admits

ALBERT J. LOWN is an evangelist from Keighley, Yorkshire, England, and a frequent contributor to religious periodicals.

the power of indwelling sin and the inability of a sensitive conscience, zealous churchmanship, and outward conformity to the commandments of God to achieve freedom from sin. “Who can say, I have made my heart clean?” said Job, anticipating Paul’s conflict and confession. But God designs and intends to wholly sanctify human hearts and lives. This revealed purpose and privilege is a golden thread of hope and assurance in God’s Word.

The Wesleys sang and taught,  
*The thing impossible shall be,  
Sin shall die out in me,*

recognizing as Paul did also, that God-given purity can be maintained only by a partnership between the cleansed believer and the “God of all power, truth, and grace” akin to the union of vine and branch. They, as we, endorsed the apostle’s wise and practical counsel to his son-in-the-faith (1 Timothy 5:21-25).

*Principles of selection* are placed before first impressions and undue personal preference in Paul’s injunction, “Lay hands suddenly on no man.” Appointments to responsible office in the church at Ephesus were not to be made on the basis of excessive but immature enthusiasm in a convert, or Timothy’s personal affinities. Natural partiality for one as over against another is not in itself good or bad. But astray from principles, and unwisely indulged, likes and dislikes can lead to unfairness, unfortunate choices, and needless hurt to others who are equally or better qualified. Impartial assessment, as far as possible, aided by wisdom from above, is essential in the choice of lay leadership.

*Warning against unspiritual associations* was also given by Paul: "neither be partaker of other men's sins." He was writing to a successful pastor!

Irrespective of age, rank, place, or grace, everyone is influenced by associations. In the fullest sense we become like those we live with; in the highest sense, men take knowledge that we have been with Jesus. Welcome or unwelcome, chosen or unavoidable, associations are privileged and perilous; but in Paul's sensible thinking, "he who has no need to trade with the devil will keep out of his shop."

*The fine line between fervour and fanaticism*, a conscience at peace or one in bondage, is indicated in Paul's advice to a sensitive heart: "Drink no longer water, but use a little wine for thy stomach's sake and thine often infirmities." The heart of Paul's concern is in the *measure*, "little," the *medicinal* use, "thy stomach's sake," and the welfare of Timothy's *ministry*, "thine often infirmities."

In a modern society, with available supplies of pure water and medical provision, the words do not buttress moderation in alcoholic beverages or contradict total abstinence. "Hast thou Timothy's stomach?" was an evangelist's reply to a healthy pleader for moderate social drinking. Anyone who would use Paul's words to argue for laxity in the use of beer, wines, and spirits is surely blind to the

appalling rise in youthful addiction in many countries today. The Nazarene *Manual* was, is, and always will be wise in its membership covenant of abstinence.

The Spirit of God, loving counsel, and sanctified common sense will ensure balance in conscience and conduct in any culture and clime.

*Remember the judgment day*, Paul urged: "Some men's sins are open beforehand, going before to judgment; and some men they follow after. Likewise also the good works . . ." Sin and saintliness have present recognition, future unveiling, and final reward. Good cannot be hid or sin concealed, ultimately. The secrets of all hearts and the deeds of all men will come to an Accounting Day, for there is no hiding place beyond the shaded valley.

The pilgrimage of all believers to the judgment seat of Christ, and of all the unsaved to the Great White Throne, is attended with challenge and comfort—to live with eternity's values in view.

The greatest evangelists have been burdened for the follow-up of initial grace, and the greatest saints have realized it must be "My Utmost for His Highest." God does redeem and remake humanity's broken earthenware, but in the highest interests of pastors and people He demands purity: "Keep thyself pure." □

## FAMILY WORSHIP

by MYRON L. TWEED

WHEN WORSHIP is a part of the family environment, the young adult absorbs the atmosphere and senses that *his parents are finding a presence beyond themselves to whom they give reverence*.

The time and place for devotions will depend upon the schedule of each family unit. Highly regimented groups may begin the day with a devotional time at breakfast. Others may find that a period of family worship would be more convenient at the evening meal.

There should be a reading of scripture from the Bible or a devotional book. Do not make the reading long. (The father need not necessarily read all the time.) Each member should have the opportunity to narrate.

Exchange ideas about the scripture. Each person should share his insights. Conversation with people is important preparation for conversation with God.

Prayer time should include special requests or needs. Each member tells his or her concerns to the entire group. Then sentence prayers are given by each member. (Long prayers are not appropriate if each family member is to participate.) Children are not



Camerique

intimidated if they have to say a sentence, telling God of their particular concerns. This procedure unites the family in caring and sharing together.

Group singing may be a part of family worship. People do not forget that which they love to sing. Use the church hymnal. If the church is promoting a "hymn-of-the-month" plan, then make that a part of family worship. The words may be beyond the understanding of younger children, yet they represent God's love and grace. Also, many new song booklets are available, and youngsters often enjoy singing folk hymns. Memories of singing together brings happy thoughts, and awaken feelings of God's love and gratitude. "The family that prays together, stays together." □

MYRON L. TWEED is a professor of music at Point Loma College in San Diego, California.

# Dealing with the Trials of Life

by BUD REEDY



Paul M. Schrock

**T**RIALS are common to us all. There are two kinds of trials. There are “hassles.” These are the minor inconveniences—a flat tire on a rainy day, an empty check-book at the check-out counter, a cold sore or a missing button. Most people have little trouble dealing with hassles. However, there is another kind of trial: the devastating kind. These trials are difficult and soul-wrenching. Many of you have experienced this

*BUD REEDY pastors the Church of the Nazarene in Hershey, Pennsylvania.*

Helps to  
**HOLY** Living

kind of trial. The loss of a job, the loss of a loved one, a broken relationship—these trials often shatter lives.

Throughout history, people have worked toward a trial-free existence. This striving has inevitably ended in failure. We cannot eliminate trials. They are part of our experience. They are with us to stay. Whether we are Christians or not, we shall experience trials. Our task is not to eliminate life’s difficult situations, but to equip ourselves for dealing with them. The opening verses of James state clearly that resources are available for coping with trials.

“Consider it all joy, my brethren, when you encounter various trials” (v. 2, NASB). Christians are to rise victorious above the trials of life. Joy here refers not just to an emotion, but to an activity, a life-style. The result of such activity is endurance toward Christian maturity, because you know “that the testing of your faith produces endurance. And let endurance have its perfect result, that you may be perfect and complete, lacking in nothing” (vv. 3-4, NASB). This testing is a purification process. As metals are heated in order to eliminate im-

purities, so the trials of life function. James’s admonition to rise victorious above life’s trials is a difficult doctrine. Of this John Wesley said: “This is a right strange doctrine!” What an understatement! In my humanness, I don’t respond to trials in this manner. It is beyond my capacity. Yet this comes to us from James’s pen in the form of a command. Commands are to be obeyed.

The hope-filled message that rises like a mountain peak from the verses that follow is this: God never issues a command unless He also makes adequate provision for us to keep that command. And so, God equips us to face the trials of life. The resources are available.

What are these resources, and how are they to be attained? According to James, prayer equips us to deal with life’s trials. “If any of you lacks wisdom, let him ask of God, who gives to all men generously and without reproach, and it will be given to him” (v. 5, NASB).

We pray in order to gain wisdom. This is not scholarly wisdom, but the power to discern right from wrong. It is the insight necessary to keep us from falling. We pray in the face of trials in order





H. Armstrong Roberts

to gain this insight. Such prayers are to be offered "in faith without any doubting, for the one who doubts is like the surf of the sea driven and tossed by the wind" (v. 6, NASB). The prayer of faith makes everything possible for him who believes (Mark 9:23). Strength, insight, perspective, trust—all the equipment needed to face life's trials are available for those who pray.

Many believers have found this prayer life difficult. However difficult, James has stated very clearly that these things are possible when we are singleminded.

Singlemindedness is the opposite of doublemindedness. A doubleminded man has two minds, two wills, two sets of goals, two sets of desires, two sets of ambitions. He is a divided person, for his loyalty is divided between faith and the world. A doubleminded person strives for the best of both worlds. A doubleminded person is like a man with one foot on the shore and one foot on the boat. He is unwilling to let go of the things of the world and become totally God's.

A singleminded person has one mind, the mind of Christ. His will is lined up with God's will. His desires, goals, and aspirations are one with the Lord's. James refers to this singlemindedness as perfection, Christian perfection. John Wesley described this as the perfection of our intentions. This perfection, this singlemindedness, is

more than adequate equipment for dealing with the trials of life.

Not long ago I visited in the home of my friends, Warren and Esther Holloway. He is such a vibrant person. You would never guess that beneath this vivacious exterior is the hurt resulting from the tragic loss of their only son. In July, 1976, Warren, Jr., was killed in a car accident. We were very close. I was devastated, as were many of his friends. It just did not make any sense to me. He was in the prime of his life, actively involved in ministry as associate pastor in the Bel Air, Md., Church of the Nazarene. As I dealt with this tragic loss of life, I experienced spiritual trauma. I was deeply hurt and none of the pat answers and old cliches seemed to

help. I walked into the funeral service wondering, as many did, how the Holloways were going to take all of this. I will never forget the witness to God's grace that took place that afternoon. They faced that event with joy! Oh, it was obvious that the grief at the loss of their son was deep, a grief I have not experienced. And yet they were witnesses to the Word! Their lives spoke to my need! There is equipment for facing the trials of life. The Holloways proved it.

Have you prayed the prayer of faith toward singlemindedness or Christian perfection? This beautiful relationship with God can be yours. It is adequate provision for dealing with even the most devastating of life's trials. □

## THE COMFORTER

*The night grew dark; my brow with fever burned,  
No human friend at hand to do me good.  
When hope for life was almost gone  
A shining Presence at my bedside stood.*

*Jesus himself laid hands upon my head  
And gently said, "My daughter, be of cheer!  
Though all may leave you comfortless,  
I've come to stay, so have no fear."*

*His promised Self, the Comforter, came in  
And instantly made all my gloom depart;  
His word, His touch, gave peace and calm,  
His joy and love filled all my lonely heart.*

*If never did I feel a throb of pain,  
If never did I know a midnight hour,  
How could my Lord reveal to me  
His comfort and His healing power!*

—HELEN R. SULLIVAN  
Wollaston, Massachusetts



H. Armstrong Roberts

# BETTER THAN IT HAS TO BE

by STAN MEEK

**A**CERTAIN OIL COMPANY claims that its product is “better than it has to be.” Its motor oil, the claim implies, not only provides the lubrication and protection expected, but assures the consumer of additives and extras that make it a superior product.

If the product really is better than it has to be, that is a good testimony to its worth. We live in a day when just getting by is apparently good enough for many. Excellence of performance and craftsmanship is rare. Few companies or individuals are willing to give that extra effort which assures superiority.

Extravagant claims are not uncommon in modern advertising, but the claims of the gospel of Jesus Christ are not excessive. God’s grace is better than it has to be. It offers not extravagance of claim but prodigality of product.

God’s grace has to be good enough to save us from the penalty of sin—both the final penalty of everlasting punishment and separation from God, and the present penalty of alienation from God and the haunting ghost of guilt. It does; hallelujah! God’s grace does what it must do, but it does more.

As with the water and fire on Mount Carmel, God has more than enough to vindicate His holy name. God not only has water enough to wash away our sins, but fire enough to lick up the sin within us. Whether it is a barrel of meal that does not waste or a cruse of oil that never fails, God’s grace is not diminished. He not only has enough to meet our needs, and to justify, but leftovers enough to embarrass our draw upon His account.

God’s grace is more than a rescue squad or a life-support system. It does more than save us and then barely keep us alive. God furnishes purpose and power for everyday life. He integrates the personality and frees it to function at its intended norm. He releases us from the delusion of self-reliance, yet never crushes the individual free spirit.

God’s grace even lifts us into the “bonus” area of living where fringe benefits abound. There’s manna waiting in each wilderness, and Eschol grapes to offset those burly giants that challenge God’s plan for our lives, and innumerable extras for everyday life. The natural man forfeits all of this when he refuses this grace that is better than it has to be.

Consider Jochebed, the mother of Moses. Instead of allowing the king’s edict to strike fear to her heart, she believed God could deliver her son out of the murderous hand of the Pharaoh. God did, but He did more. He not only delivered the child Moses from death, but arranged for his own mother to nurse him and paid her a handsome Egyptian salary to boot. God’s grace is better than it has to be.

Or consider a more recent example of God’s better-than-it-has-to-be grace. Cape Verdian Nazarenes living in Lisbon, Portugal, needed a place to worship. The only thing that seemed to be available was the street floor of a new high rise building at a cost of

---

*STAN MEEK pastors the First Church of the Nazarene in Pittsburg, Kansas.*

\$200,000. While Rev. Everette Howard had been busy raising funds for this Garnet Howard Memorial church, he and the family of retired missionaries at Casa Robles were also praying about a price that seemed too high.

Recently, Rev. Earl Mosteller found a much better place with double the floor space for only \$80,000. God's grace is better than it has to be, and now, every Sunday, about 150 Nazarenes gather in front of that building to sing, pray, and thank God for the church home they are soon to enjoy.

This is not to suggest that all of God's roses have thornless stems, or that God's grace exempts one from the trials or discomforts of life. God does not always provide lavishly for His children, or, like an indulgent father, spoil them with unnecessary favors.

God does, however, often surprise His children with unexpected blessings, reminding them of His super-adequacy.

Whether our age is one of affluence or scarcity, God's manner of working is never mediocre. If this is an age of low productivity, poor workmanship, and minimal service, that isn't the way God's industry is run. God is still producing quality and quantity, marketing what He produces, and giving outstanding service on His product. God's product never fails; we just fail to use it. And when we do, we invite failure.

Even then—should we fail or have a major breakdown—God's grace is better than it has to be. God specializes in mending, healing, restoring, and making new. What a God! What a grace! It is better than it has to be, and better than we deserve. □

by WILLIAM GOODMAN



## the **MOCKER**

**T**HANK the Lord my child was only drinking wine and not into drugs!" said the mother as we [police] delivered her 15-year-old child home late one night.

"We don't drink. We do have a glass of light wine with our meals; it gives us the perk we need at the end of the day," said a young businessman.

Wine as an alcoholic beverage is a drug. It is not a stimulant, even though its exhilarating effect makes people think it is. Wine is a depressant that affects the central nervous system. It acts much like an anesthetic to depress the activity of the brain. Wine is an intoxicant, and the first ounce that reaches the brain begins to put the brain to sleep.

Wine is not digested, it is absorbed directly into the bloodstream, where it is carried to all parts of the body, including the brain. The body disposes of wine-alcohol by elimination (5 to 10 percent) and oxidation (90 to 95 percent). Oxidation takes place in the liver at a fairly consistent rate, and the decline in the blood-alcohol concentration averages about .018 percent an hour.

If a person who weighs 140 pounds drinks one three-ounce glass of natural wine (12% alcohol), the blood alcohol ratio would be .03 percent. How critical is that? Medicolegal experts say people are incapable of driving safely at or above .05 percent. Increased accident causation is noticeable at .04 percent. At .02 percent blood alcohol, a person will feel pleasant, elated, giddy, loose. If a person consumes a three-

ounce glass of fortified wine (18% alcohol), their blood alcohol would be .05 percent and their behavior would be impulsive, and their inhibition lessened.

Solomon wrote, "Wine is a mocker, strong drink a brawler; and whoever is led astray by it is not wise" (Proverbs 20:1, RSV). Wine is the most deceptive of all alcoholic beverages because many make the unscientific assumption it is harmless.

"Liver disease, increased by higher consumption of alcohol, is the fastest rising cause of death in the nation. The soaring death rate of liver disease is caused by the growing popularity of wine drinking," according to Dr. John M. Senior, clinical professor of medicine, University of Pennsylvania. "By 1985, liver disease is expected to rank behind only heart disease and cancer as causing the most deaths."

Wine is addicting and anyone who is addicted to wine will tell you that it is terribly difficult to break the hook of the "soft, siren, mellow juice of the vine." "As a brain surgeon, I have yet to meet a moderate drinking colleague . . . moderation is a terrible fallacy," says Richard E. Strain, M.D.

Every year 200,000 Americans become part of the ever-increasing rank of 10.5 million alcoholics. Two hundred thousand Americans die as a result of alcohol each year. Seventy percent of all crimes, ranging from rape to forgery, are directly related to alcohol. The drinking of wine is involved in all these sad, horrific statistics. The logical approach to stopping the sad commentaries on injuries and destruction to life is to be willing to abstain from all alcoholic beverages.

At this point, our argument against alcohol is best framed in expedience. For a clear head, healthy liver, a certainty of not becoming an alcoholic or statistic, the wise person refuses the mockery of wine. □

*WILLIAM GOODMAN is a Nazarene elder and freelance writer, currently residing in Kansas City, Missouri.*



# The Sabbath and Its Relationship to Modern Times

by PAUL W. BEALS

**John Wesley taught that Christians were obligated to observe Sunday ... He believed that this observance was a part of the moral law.**

**T**HE FOURTH COMMANDMENT IS: “Remember the sabbath day, to keep it holy” (Exodus 20:8). Let us renew our understanding of the sabbath and its relationship to modern times. Several questions confront us: the origin of the sabbath, its history, its meaning, its relation to Sunday, its relation to the Christian Lord’s Day, and its application to the times in which we live.

Historically, the sabbath is older than the Bible or the Church. The root of the Hebrew word *sabbath* means “to cease, to rest, to interrupt one’s work.” The use of this concept is as old as creation itself: in six days God finished the heavens and the earth, and He rested on the seventh day. He blessed this day and made it holy because He rested on that day.

The sabbath was first observed by the Israelite people shortly after they began their journey from Egypt’s slavery to the promised land. They were in the desert en route to Mount Sinai when God provided manna for them to eat. They were instructed to

gather manna for six days, to gather a double portion on the sixth day, and not to gather on the seventh day, a day of rest. Later, when they arrived at Mount Sinai, the observance of the sabbath was made one of the Ten Commandments:

Remember the sabbath day, to keep it holy. Six days you shall labor, and do all your work; but the seventh day is a sabbath to the Lord your God; in it you shall not do any work, you, or your son, or your daughter, your manservant, or your maidservant, or your cattle, or the sojourner who is within your gates; for in six days the Lord made heaven and earth, the sea, and all that is in them, and rested the seventh day; therefore the Lord blessed the sabbath day and hallowed it (Exodus 20:8-11, RSV).

It was made into a perpetual covenant, a permanent clause in the contract between God and His people. Forty years later it was reaffirmed before the Israelites entered the Promised Land.

The Israelites were not the only people of ancient times to rest one day in every seven. Ancient records show that the Assyrians and the Babylonians had weeks of seven days, with the seventh a day of rest.

Jesus Christ honored the sabbath. He declared it was of value to men. At the same time He opposed the senseless rules of the Pharisees. Our Lord’s mode of observing the sabbath was one of the main features of His life.

The sabbath day was observed for the first 20 years by the Early Christian Church. Then the Church

---

PAUL W. BEALS is a Nazarene elder and an associate professor of education and director of secondary education at Jamestown College, Jamestown, North Dakota.

Camerique

began observing the first day of the week instead. Several reasons may have led to the change: the first day of the week was the day of Christ's resurrection, a day of victory. Apparently, it was also the day of Christ's next appearance. The day when the Holy Spirit was given, the day of Pentecost, was on the first day of the week too.

Under the ministry of the apostle Paul, the first day of the week was observed as a regular day of worship. The seventh day was disregarded as being a part of Judaism. The Gentile Christians were urged to be tolerant of Jewish Christians, but to avoid things from Judaism.

The first day of the week was called "the Lord's Day" by Ignatius in about A.D. 110. "Let us no more sabbatize," he said, "but let us keep the Lord's Day on which our life arose." Another document from about the same period, the *Didache*, speaks of coming together and breaking bread on the Lord's Day.

Justin Martyr, in the middle of the second century, was the first Christian to have called it Sunday, the day when Christians assembled for worship.

In the Early Church, emphasis was at first on worship. Slaves had no opportunity to rest. Then in A.D. 321, Constantine's edict commanded observance of Sunday as a day of rest. The "heathen" also wanted a day of rest. Also, Leo's decree of A.D. 469 described it as a day of rest, a day to cease from labor. This was still the official church attitude even until the time of the Reformation, though observance was sometimes ignored.

The Reformers continued the Sunday tradition. Martin Luther said, "Because Sunday has been appointed from earliest times, we ought to keep this arrangement, that all things may be done in harmony and in order, and no confusion be caused by unnecessary novelties." John Calvin desired to rest from works, that God might work in him. He wished to spend the day in hearing the Word of God, partaking of the sacraments, and in public prayer. He believed that dependents and servants should also rest.

In the 17th century, the English Parliament approved the longer and shorter catechism, which read in part as follows:

The sabbath is to be sanctified by holy resting all the day, even from such worldly employments and recreations as are lawful on other days; and spending the whole time in public and private exercise of God's worship, except so much as is to be taken up with works of necessity and mercy.

John Wesley taught that Christians were obligated to observe Sunday, and dismissed the negligent from his societies. He believed that this observance was a part of the moral law.

The Roman Catholic viewpoint during the same period was that mass in the morning, with the rest of the day in pleasure, was a concession to human weakness, not an exposition of Christian doctrine.

We have spent some time reviewing the origin of the sabbath and its development into Sunday observance. In this way we have amplified the words of our text "remember" the "sabbath." Last but not

least is the word "holy." "Remember the sabbath day, to keep it holy." A holy day—separate from evil. A holy day—sacred, not common or profane, not secular.

People like something holy they can *see* or *hear*. Idols, saints, and holy water are examples. In the jungles of Central America the Indian farmer believes his field is holy ground, a sacred altar. His labor is in partnership with the divine. Many primitive religions have sacred *words*, which must be repeated precisely to achieve the correct answer from the supernatural. The Tibetans have a sacred prayer wheel: the prayer is written on the prayer wheel and every time the wheel turns the prayer is automatically forwarded to the Almighty. The Navajo Indians make sacred prayer sticks, which must be constructed correctly to achieve the desired result. The ancient Israelites, too, had their holy objects, such as the sacred stone tablets on which the Ten Commandments were written. (They were broken when Moses saw the golden calf—otherwise everyone would have worshiped the tablets!)

The Bible is more concerned with holiness in *time* than with sacred objects. Sacred moments! Moments of prayer! Moments of holy insight! Sacred sabbath days! Sacred time! Holy time is unique in Judaism and Christianity. Time is the process of creation. The things of space are the results of creation. We can't bring back time—sacred time or common time. We can only kill time. The sanctification of time is the heart of Jewish and Christian devotion to God! A day *not* to use money for common, ordinary things! A day *not* to worship the idols of technical civilization!

The spirit of Christianity is the ability to sanctify a moment, to sanctify a day! Make it holy, not common!

Jesus said: "The sabbath was made for man, not man for the sabbath!" (Mark 2:27, RSV). □

## My Reward

*I do not ask that Thou shouldst  
smooth  
This rugged path I climb;  
But give me inner strength to pray,  
"Lord, not my will but Thine."  
Let me not seek to be consoled  
When sorrow comes my way,  
But let me reach out lovingly  
To others, day by day.  
Let me not seek for earthly praise  
For any errand run,  
Your smile in heaven my reward  
When life on earth is done!*

—ALICE HANSCH MORTENSON  
Racine, Wisconsin



# SPIRITUAL MALABSORPTION

by WILLIAM L. POTEET

**E**IGHTEEN-YEAR-OLD Amy Brown of Jackson, N.J., eats a dozen eggs for breakfast and two steaks for lunch in order to keep her weight up to 90 pounds. Doctors tell her there is little she, or they, can do about her metabolic disorder—except for her to keep on eating.

Amy suffers from malabsorption, an unusual syndrome that usually afflicts younger children, which requires her to eat almost hourly to replace lost potassium in her body. Doctors predict her condition will change, for better or worse, as her body completes maturity in the next few years.

Meanwhile, her meals equal those of four adults. Her food bills alone take \$170 a week out of her father's salary as a township public works employee.

Until the illness struck at age 14, she was a healthy, energetic teen-ager. Now, in and out of hospitals periodically, she is weak unless she eats constantly.

The sad fact is that numbers of people who sit among us Sunday after Sunday suffer from a syndrome similar to Amy's—not a metabolic disorder resulting from loss of potassium, but spiritual malabsorption.

The prophet Micah wrote, "You will eat but not be satisfied; your stomach will still be empty" (Micah 6:14, NIV). J. B. Phillips paraphrased those words, "There will be famine in your heart."

There are folks in your church and in mine who attend regularly, ingesting a prodigious diet of spiritual food, yet never growing spiritually as a result. Some have never even come to the place of acknowledging Jesus to be the Lord of their life, even though they have given mental assent to the gospel and perhaps supported the church with their attendance and giving for years!

Paul warned Timothy that in the last days there would be those who, "having a form of godliness but denying its power" are "always learning but never

able to acknowledge the truth" (2 Timothy 3:5, 7, NIV).

It breaks a pastor's heart to greet folks at the door Sunday after Sunday who express appreciation for "good preaching" but whose absorption of spiritual food leads them neither to faith in Christ nor to spiritual development.

But not only can individuals suffer from spiritual malabsorption, entire congregations can be afflicted by the syndrome as well.

Ray Stedman tells the story of a man who was taken through an oil refinery and shown acres of fabulous machinery. When his tour was over he said to his guide, "You've shown me everything except your shipping department—where is that?"

"Oh," the guide replied, "we don't have one."

"You don't have a shipping department?" The man asked in amazement! "Why not?"

"Well, you see," the guide said, "it takes all the oil we produce to run the machinery we have here."

Unfortunately, that's a parable of the church in many places, operating only for its own benefit, absorbing all the physical and spiritual energy produced to maintain itself.

How does one overcome spiritual malabsorption? First, eat the right food, that which is capable of producing spiritual maturity. Peter urges us "like newborn babies, crave pure spiritual milk, so that by it you may grow up in your salvation, now that you have tasted that the Lord is good" (1 Peter 2:2-3, NIV).

But like its physical counterpart, reaching spiritual maturity involves far more than achieving and maintaining homeostasis, the state of stability and equilibrium toward which all nature strives. Mere maintenance of the status quo is not enough. We have within us an innate, God-given urge to develop our abilities, to grow. So the Word commands us to "grow in the grace and knowledge of our Lord and Savior Jesus Christ" (2 Peter 3:18, NIV).

This growth, whether on a personal or congrega-

*WILLIAM L. POTEET is pastor of the Union, Missouri, Church of the Nazarene.*

tional level, has three dimensions: spiritual, organic or functional, and reproductive.

Spiritual growth in a congregation is measurable in terms of victorious prayer, fervor of evangelism, a relevant message, triumphant faith, an attitude of expectancy, membership involvement, a dynamic fellowship, and the reality experienced in worship. For the individual there will be a deepening of relationship with the Lord, a sensitivity of spirit, and a desire to share one's faith in meaningful ways.

Organic or functional growth relates to the development of leadership skills and the discovery and utilization of the gifts of the Spirit. God has given every born-again believer one or more spiritual gifts for use within the context of His body, the Church. The congregation grows functionally (as does the individual believer) when the gifts of the many members are used interactively to promote the cause of Christ, according to God's "body building" program

laid out for us in Ephesians 4. His body "grows and builds itself up in love, as each part does its work" (Ephesians 4:16, NIV).

Amy Brown, fighting to maintain her weight at 90 pounds, says of her physical problem: "I'm not going to let this thing beat me. I wanted to become a cop, but that's definitely out of the question. I may want to be a secretary or possibly a singer. I want also to have children."

Both the Church of Jesus Christ and the individuals who comprise it are born to reproduce. Without the birth of new believers into the Family of God, a local church soon dies. Without the exhilaration of being a personal soul winner, one's spiritual vitality begins to diminish.

It's healthy to have a voracious appetite for the Word. But if it does not eventuate in measurable growth, it may be a symptom of spiritual malabsorption. □

## NAZARENE ROOTS



### **BIRTH OF THE CHURCH OF THE NAZARENE PILOT POINT, October 13, 1908—Tuesday Morning**

"Bro. R. B. Mitchum spoke in a very tender way of the gracious leadings of God up to this moment. He desired to move that 'The union of the two churches be now consummated.' . . . Bro. Ruth said, 'Being of one heart, we should all be one organic body.' He seconded the motion.

". . . The motion being put, it was passed unanimously by a rising vote, amid great enthusiasm.

"The burst of holy joy continued for several minutes, brethren of the South throwing their arms around brethren of the North, East, and West, at the

same time singing a new hymn written for the occasion to the tune of 'Dixie'. Soon the inside of the tent became too small for the freedom of such a joy, and the people began marching out and around the great tent, with waving handkerchiefs and shouts of joy, and eventually formed in an immense solid circle on the grounds, where Dr. Bresee mounted a chair and addressed the multitude in words of inspiration, which moved the hearts of all."

*—Excerpted from the General Assembly Journal, 1908.  
General Church Archives, Kansas City, Missouri*

*STEVE COOLEY, director of Archives*

**T**WO PREACHERS were discussing the financial situations of their churches. The holiness preacher, whose congregation numbered about 100, mentioned the total giving of his church for the past year.

The other, pastor of a liberal church which ran three Sunday morning services totaling about 900, was astounded. "Why," said the flabbergasted minister, "your little church takes in more money than my big church does!" Then wistfully he added, "If it weren't for the bingo parties, our church would never make it. How do you do it?"

"My people practice tithing," was the simple reply.

Tithing is more than giving money. Tithing is a spiritual act. In Malachi 3:10, God promises those who bring in the tithe that He will open the windows of heaven and pour out a blessing so great there will not be room enough to receive it. That blessing may not always be material. It is often a spiritual blessing.

In one of our pastorates, it fell my lot to be one of the money counters. During that time, I made a surprising discovery. I noticed that people who began tithing right away when they were saved followed through consistently in good times or bad. They also were the ones with the best attitudes about other matters in the church.

On the other hand, those who didn't start tithing immediately after conversion never did get into the habit. They might give occasionally for some special thing, but not on a regular basis. I also observed, over a period of time, that the non-tithers seemed to be the people who had the most unresolved spiritual problems as well. They were also the loudest critics of the overall program of the church.

Some get into trouble over tithing because they pay bills, buy groceries, gas, etc. Then they try to tithe from what's left, but there is never much, if anything, left.

*LOLA M. WILLIAMS is a free-lance writer and a pastor's wife at Sheridan, Illinois.*

# "WITH- OUT THE BINGO PARTIES, WE'D NEVER MAKE IT!"

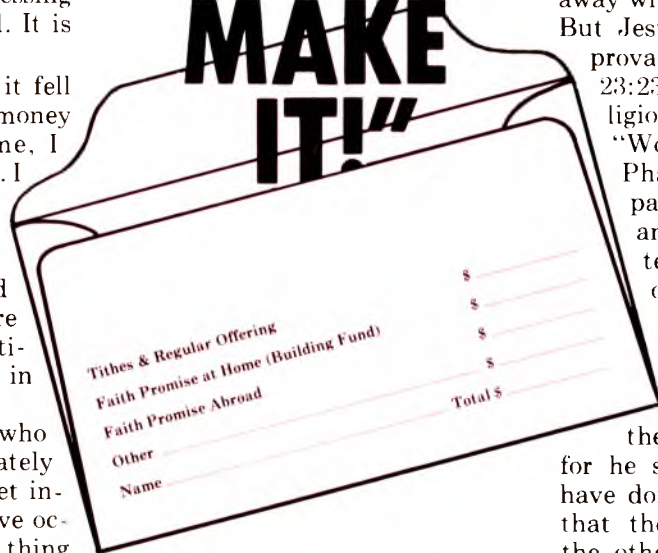

by LOLA M. WILLIAMS

The Bible clearly states that the "firstfruits" should be brought to God, not the leftovers.

If we get into the habit of paying God's share first (and we *pay* our tithe, not *give*, because it already belongs to God), then somehow the other 90 percent seems to stretch to cover our other needs. Perhaps one reason is because we learn to budget the rest more carefully; but let's not rule out the power of God. The same Lord who could feed 5,000 people from a

small boy's lunch can stretch our paychecks to cover the necessities when we honor Him as we should.

Brother Turner had a well-developed sense of spiritual priorities and his life was a blessing to others. Though limited in education and earning power, he was deeply in love with his Lord. Each Friday afternoon when he collected his paycheck, he would go by the bank to cash it, then head straight for the church office to hand the secretary his tithe.

One day she said, "Brother Turner, why don't you just wait and put your tithe in the offering plate on Sunday morning like everyone else does?"

"Oh, no, ma'am. I prefer to bring it right over. Suppose I should die before Sunday morning gets here? I don't want God's money to be in my pocket when I go to meet my Maker."

Some argue that tithing is an Old Testament practice, done away with in the New Testament. But Jesus put His stamp of approval on tithing. In Matthew 23:23, Jesus spoke to the religious leaders of that day. "Woe unto you, scribes and Pharisees, hypocrites! for ye pay tithe of mint and anise and cummin, and have omitted the weightier matters of the law, judgment, mercy, and faith: these ought ye to have done, and not to leave the other undone."

Jesus was not criticizing them for being strict tithers, for he said, "these ought ye to have done." He was telling them that they stopped too soon on the other matters.

How much is the tithe? The Bible plainly says it is 10 percent, but where do we start to figure that 10 percent?

Ray made a point of letting everyone know that he tithed. He wore it like a badge of honor. He earned a good hourly wage in one of the local factories, but deducted from each paycheck were the usual state and federal taxes, Social Security, and union dues. Since he had consolidated all his bills through the credit union, a sizable chunk of his check was also deducted each week to pay back his loan. What he brought home was



considerably less than what he actually earned. He tithed, by his own admission, only on that part of the check that was his take-home pay. But—the government took out taxes on the *entire* check, *before deductions!*

Can we do less for our Lord than we do for our country? Kenneth L. Wilson said, “Stewardship is not a classroom exercise in fractions. It is a homework assignment in total living.”

The Bible tells us that “Unto whomsoever much is given, of him shall be much required” (Luke 12: 48). The late Peter Marshall, popular chaplain of the U.S. Senate, put it this way. “Let us give according to our incomes, lest God make our incomes match our gifts.”

It is not a sin to make money, as long as we acknowledge God’s right to our fortunes, be they great or small. John Wesley said, “Make all you can, save all you can, and give all you can.”

We ought to tithe because it’s right, because it’s scriptural, and most of all because we love God. “God loves a cheerful giver” (2 Corinthians 9:7, NIV). No matter how much we give, we can never outgive the Lord. □

## GOD KNOWS

*God knows how much or how little I love Him;  
He hears how much or how little I pray;  
God knows my thoughts as I waken at morning;  
He sees the paths I choose day by day.*

*God knows how much or how little I serve Him;  
He judges well the intent of my heart.  
My Lord can see, when no other one can fathom,  
How far from the world my life is apart.*

*God knows how much or how little I give Him,  
Tithe or an offering, or widow’s mite;  
He sees how much is left for my spending,  
Which proves if my values are focused aright.*

*God knows my deepest emotions toward others,  
The love or hate of my heart clearly shows;  
How wonderful on our journey to heaven,  
To feel secure in the truth—God knows!*

—EDNA MOORE SCHULTZ  
*Depew, New York*

## Book Brief

### COUNT YOUR PEARLS



ESTHER LUNSFORD,  
*author*

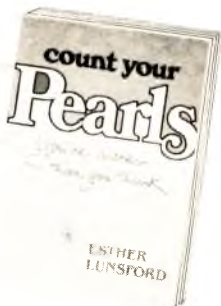

**E**VEN THE POOREST of us has a fine collection of pearls. How long has it been since you took stock of your pearl collection?

Esther Lunsford is committed to the concept that most of us become so absorbed with the daily routine that we do not take time to see how rich we really are. With our myopic vision, we often fail to revel in the glorious panorama of the horizon. We become prisoners of circumstances, conditions, and events.

Thanks to Mrs. Lunsford, the reader pauses and

looks out a kitchen window, or into the face of a child.

This is delightful reading, not just because of the author’s warm spirit, which gives kind of an incandescence to what she writes, but also because of her spiritual perception. There isn’t a boring paragraph or poorly turned sentence in the whole book.

Why would a busy wife and mother take time to write such a book? Listen to author Lunsford:

“It was never hard for me to believe in God and His providence. My mother had a gigantic task of rearing six of us children, all by herself, during depression years. That she succeeded was a miracle of grace and faith, evidenced by God’s presence in our home. He supplied our needs and blessed around the family altar.

“Many times I have shared those experiences with others, and finally those stories became a column in our local newspaper, which I wrote for two years.

“At the urging of several readers, I put the stories into book form, the manuscript which I submitted to Nazarene Publishing House.”

And your Publishing House is happy to present this charming volume to you. □

Beacon Hill Press of Kansas City  
*To order, see page 23.*

# the editor's STANDPOINT

## REDISCOVERY AND REVIVAL

Is the Church of the Nazarene rediscovering its human founder, Phineas F. Bresee? I hope so. "Follow me," cried the apostle Paul, "as I also follow Christ." Of all the men who gave direction and impetus to our work in its early days, none is a choicer, safer model than P. F. Bresee.

Our publishing house has recently reissued *Phineas F. Bresee: A Prince in Israel*, by E. A. Girvin. It appeared first in 1916 and has long been out of print. I read it a few weeks ago, and it stirred my heart, which some of my friends regard as a difficult feat.

The PALCONs conducted this past summer featured D. Paul Thomas in a dramatic presentation, *The Sun Never Sets in the Morning*, sketches of the life and work of Dr. Bresee. To me, Thomas made Bresee live. The performance moved me deeply, and made me want to serve Jesus Christ, and forward the mission of our church, with fresh zeal and dedication.

A chapter in Carl Bangs's little book, *Our Roots of Belief*, is devoted to Bresee, and relates some in-

triguing details not given elsewhere. Like everything Bangs has written, it is well done.

The first Church of the Nazarene was organized by a man who was willing to pay any price to preach the gospel to the poor, and to herald purity of heart and life as a present possibility for all Christians. Bresee was passionately committed to the doctrine of entire sanctification as a second crisis of grace wrought by the baptism with the Holy Spirit. To this he gave his energy and thought, his time and his money, his very life during the most productive period of his career. Other preachers, and a host of godly laymen, joined him in the work of establishing "centers of holy fire" across America and around the world.

I do not want to see what began as holy fire end up as cold ashes. I pray that God will mightily revive our church and rescue us from any doctrinal, ethical or moral compromise that militates against the founding vision and aim.

Read Girvin and Bangs. See Thomas. It will do you good. □

## LIVE UP TO YOUR NAME!

Parents can't always be trusted with the naming of their children.

James S. Hogg, a former governor of Texas, named his two daughters Ima and Ura.

Erskine Hewitt, according to Brendan Gill, was named in a strange way. At his christening ceremony, his father's glance fell on the tombstone of Robert Erskine, buried on the estate in New York where the ritual took place. "Erskine was named after the tombstone," said his brother Edward, and added, "He grew up rather gloomy."

Even when motives are good, a name may turn out unfortunate in the opinion of its bearer. I named a son after a great Scottish freedom-fighter. Present day stereotyping has attached this name to effeminate, limp-wristed characters in books and plays.

God did not trust the naming of His Son to earthly parents. An angel instructed Joseph, "You shall call his name JESUS, for he shall save his people from their sins" (Matthew 1:21).

Even the Lord's name has suffered horribly in the minds and mouths of a god-hating world. "Jesus" and "Christ" are used in speech and print today as obscenities and profanities. More persons use the Lord's name abusively than worshipfully.

But the name of Jesus receives its saddest profanation when professing Christians contradict His Spirit and life by their own.

"Jesus" means Savior, and we honor His name only as we live as He lived, in the interest of saving others. We bear His name in vain unless our time, funds, energy, and abilities are committed to His work.

He especially cared for the poor, widowed, bereaved, sick, oppressed, and lost. His enemies were found chiefly among the ruling classes, often among leaders of religious institutions, who exploited the common people to protect and increase their own vested interests. His name is disgraced when the church neglects the poor and courts the privileged. □

The first Church of the Nazarene was organized by a man who was willing to pay any price to preach the gospel to the poor, and to herald purity of heart and life as a present possibility for all Christians.

---

## MOVING "STANDPOINT" AGAIN

With this issue, the editor's writing returns to the center of the magazine. I experimented briefly with a one-page editorial on the inside back cover. The only response I got to the change was negative.

I liked it because it was less work, for I had to provide copy for a smaller space. Doris thought the editorials there were harder to read. Although she was too gentle and kind to say so directly, she also thought they were getting duller, and would not be read for long. Bud Lunn concurred with her criticism. The two of them represent a formidable power structure, with a lot of influence over my life, so here I am in the middle again.

No apologies are being made for the experiment or for its abortion. Efforts will be made from time to time to change, to innovate, to reconstruct. Otherwise, the magazine will not be improved and our readers will be cheated.

Sometimes, however, improvement means going back to a former way of doing something. The saying,

"You can't turn the clock back," is for cowards and fools. If the clock needs to be turned back in order for it to tell time correctly, that is precisely what must be done. Editors and churches need to be flexible enough to say, from time to time, "This isn't working out. The old way was better. Let's go back."

For example, if we have quit praying, trying to find a substitute for it is futile. The wise thing is to go back to praying. A similar case can be made for biblical preaching, for tithing, for repentance, for baptism with the Spirit, and for revivals.

I remember when Roosevelt campaigned under the slogan, "Don't swap horses in the middle of the stream." Sounds smart, but a lot depends upon the quality of the horse. The alternative could be drowning along with the horse!

Anyhow, we'll keep working at the job of trying to produce a magazine that honors the Lord and helps the people. And we'll try to keep all gears functioning smoothly, including reverse. □

## "COMMANDING LAY FIGURE"

We are in "The Year of the Layman" for the Church of the Nazarene.

I thought of this when I read *Corsair*, a biography of J. Pierpont Morgan by Andrew Sinclair. I was drawn to the book by a fondness for biography and because Doris, on her mother's side of the family, is a distant poor relation to the famous millionaire. I was attracted to the biography, also, because I had read in another book that Morgan was "the most dominant banker who ever lived," and "the supremely commanding lay figure in the Episcopal Church."

That he was the world's most powerful financier was no credit to his church. That he was its foremost layman was a disgrace to his church. For Morgan was a man who could hold the most orthodox religious opinions side by side with the most unscrupulous moral behavior. His affairs and adulteries were discreetly private, but they were also public knowledge. As his biographer says, "He was notorious for traveling with beautiful women on the *Corsair* [his yacht] or in his private railroad cars while his wife stayed at home." He even took a mistress along when he

attended the Triennial Conventions of his church. To the everlasting discredit of the church, Morgan had no pastor or bishop who would rebuke his abominable behavior with the courage that John the Baptist displayed in reproving Herod.

Laymen in our church should not expect honor and deference because of their financial wealth or business stature. If they sin, their pastors should call them to repentance in unminced language. No layman has a better friend than a preacher who will be Nathan when that layman has been David.

Conversely, no pastor has a better friend than the layman whose life adorns the gospel of Jesus Christ. His most convincing arguments for the truth and power of what he preaches are the people who live in obedience to the Scriptures.

Our preachers should not fear money. Those with sense enough to make it should have a voice in the church's use of it. But money should never buy acceptance and control if the moneymakers and money-givers are corrupt! □

the United States, have engaged in methods to sell these bottled formulas to women of third world countries which have resulted in over a million deaths per year with a total of some 12 million babies' deaths to date.

When the World Health Organization asked for passage of a resolution to persuade the governments of these countries to encourage the manufacturers of baby formulas to cease the despicable sales methods, only the United States, at the urging of President Reagan, voted against the resolution, under the pretense that it was an infringement on the free enterprise system. Is the right to market a product more important than the lives of millions of babies?

Further, there are other millions that die from starvation and disease. That doesn't seem to bother too many people, as I hear many

church people who advocate the elimination of the welfare system and food stamps.

I read in the Bible where Jesus Christ said I was hungry and you didn't feed Me. I was thirsty and you gave Me no drink, I was naked and in prison and you visited Me not, and inasmuch as ye did it not unto the least of these my brethren ye did it not unto Me. How are we going to reconcile our political actions with our claims of love and compassion?

—Thomas G. Carson  
Decatur, Georgia

#### APPRECIATION

I appreciate your sense of fairness and understanding. As a layman of about 35 years in our church, I sometimes feel the gap between leaders and followers is too great. I believe we have good leaders, but they are not infallible.

I worked for 25 years for IBM.

One thing that makes them great is that they not only accept suggestions, they encourage and pay for them.

I read the *Herald of Holiness* with interest. May God bless your "labor in the Lord."

Harold W. Eccleston  
Binghamton, New York

#### CONTEMPORARY ENGLISH URGED

Hearing young, non-Christian men talk of church, the first things said are "thees, thous . . ." Many Christians use old English with genuine sincerity, but many young men feel that it's a great big facade. I'm convinced that Jesus preached in contemporary language. The church should act on 1 Corinthians 1:17: ". . . preach the gospel—not with words of human wisdom lest the cross of Christ be emptied of its power" (NIV).

Ray Parra  
Hayward, California



by ERNIE GRAY

## The Power of Prayer

**WE WERE PASTORING** a small country church outside of Nashville, Tenn., my wife, daughter, and I, when the Lord blessed us with an answer to our prayers. We had waited seven long years for another child, and finally God was giving us one. As the months of Amelia's pregnancy passed by, we patiently waited for what we hoped would be a boy.

But then problems came; she went another month, and still no baby. Her doctor admitted her to Vanderbilt Hospital. Induced labor was attempted for about four hard, cruel days. The baby's coming was prevented by a mass of scar tissue which formed after our first child was born.

Doctors opposed a C-section; it might endanger Amelia's life. The sustained labor was causing heart trouble. Finally the doctors told me they had done all they knew to do, and it looked like my wife was not going to make it. They thought the baby could be saved, but there wasn't much hope for my wife. They told my wife the same thing, but being a strong

Christian, she testified to her doctor, saying, "God has given me this baby and I know that He won't let me down now."

The only thing we knew to do was pray. A few hours later, they came to us with worse news. They had given mother and baby up to die. My whole world began to crumble before me. I prayed desperately for God to spare them both. Our pastor and Christian friends joined with us in prayer.

My wife was taken to the delivery room. What was only a few minutes seemed a lifetime. Then the nurse came and said, "Mr. Gray, you can go in now to see your wife, and baby boy." God had answered prayer, and the hospital staff gave complete credit to God.

When this was all over and my wife was in her room, her doctor came in and said, "Mrs. Gray, I was raised in a Christian home. My parents are Christians. But I was a doubter; I didn't think God really did those miracles that my parents and you believed in. I thought healing came only from a doctor. But what happened to you has made me a believer. After that baby was born, I knelt and gave my heart to God. And then I called my parents long-distance to tell them what happened. I'm glad now that I really know the Great Physician."

After hearing all this, my wife and I knew the purpose behind God's plan; it was to save that doctor. My faith in the power of prayer has been strengthened. □

**"By ALL MEANS...  
Save Some"**

# IN THE NEWS

## PEOPLE AND PLACES

**Rev. Terry L. Irish**, pastor of the Cle Elum, Wash., church, was recently selected as one of the Outstanding Young Men of America for 1981.

The certificate says in part, "... In recognition of outstanding professional achievement, superior leadership ability and exceptional service to the community." □

**Rev. Paul M. Phipps**, pastor of the Odon, Ind., church, has received the "Outstanding Young Man of the Year" award for 1981. This award is presented annually by the International Jaycees of America to young men who have had outstanding professional achievements, superior leadership ability, and exceptional service to the community. □



**Dr. Keith Venum** resigned his position as chairman, Department of Anesthesiology at Lakeland General Hospital in Florida, to go to Swaziland as a short-term missionary for the Division of World Mission. Dr. and Mrs. Venum and their two children, Kristen and Karen, arrived there July 1.

Dr. Venum is teaching a one-year course for five Swazi nurses which will lead to certification as nurse anesthetists by the Swaziland Medical and Dental Council. Two graduates will remain and work at the Nazarene Hospital in Swaziland after the course is completed. Mrs. Venum, the former Judy Pepper, has a master's degree in reading and will be assisting Dr. Venum with his course. Dr. and Mrs. Venum are members of the Lakeland, Fla., First Church. □

### TNC ADDS NEW FACULTY

Trevecca Nazarene College began its 81st year of operation September 7. Applications by new students show a five percent increase over those of last year.

The new faculty for 1981-82 includes Stephen Farnsley, Deborah Wilson, Morris Stocks, Craig Keen, Randy Carden, and Susan Johnson-Miller.

Stephen Farnsley joined the full-

time faculty this fall as an assistant professor of music with a concentration in band and instrumental music. Farnsley is a graduate of Indiana Central University with a Master of Music in performance from Ball State University. He has completed all residency requirements for the Doctor of Arts degree from Ball State.

Deborah Wilson became a full-time instructor in allied health. Mrs. Wilson holds degrees from Olivet Nazarene College, as well as from Trevecca Nazarene College. A physician's assistant, she comes to Trevecca from the campus Family Practice Clinic.

Morris Stocks has been named an assistant professor of business. He is a '77 Trevecca graduate and a certified public accountant, and has been employed by the state of Tennessee and in private industry.

Craig Keen joined the faculty as an assistant professor of philosophy. Keen holds the bachelor and master's degree from Bethany Nazarene College; the M.Div. from Nazarene Theological Seminary; and holds candidacy status for the Ph.D. from Claremont Graduate School.

Randy Carden, a 1978 Trevecca graduate, received his M.A. from Middle Tennessee State University. He is an instructor in psychology.

Susan Johnson-Miller is director of Trevecca's new Kinderhaus and an instructor in education. A graduate of Olivet Nazarene College, Ms. Miller has done graduate work at Wayne State University. □

### A NATIONWIDE CALL CELEBRATION OF AGING DAYS November 26-29, 1981

On the eve of the 1981 *White House Conference on Aging* (November 30—December 4), churches are called upon individually to recognize and in some way celebrate the aging members of their congregations.

The Church of the Nazarene has an adequate approach to this call through its Senior Adult Ministries program. This would be an ideal time to start if no Senior Adult Ministries program is in operation in your church. (For packet of materials, write Senior Adult Ministries, 6401 The Paseo, Kansas City, MO 64131.) The Thanksgiving season is perfect for celebration dinners.

Sunday services could honor and highlight senior adult members. A retiree could give the message and other senior talent could be used where personnel and circumstances permit.

The national celebration will be climaxed by an interfaith service, 4 p.m. Sunday, November 29, at the National Cathedral in Washington under the direction of former Commissioner Dr. Arthur S. Fleming.

NICA (National Interfaith Coalition on Aging), a voluntary association of church bodies for the promotion of "spiritual well being" and programs for the aging through congregations, is sponsor of this *Celebration of Aging Days*. □



**Dr. B. Edgar Johnson**, general executive secretary, is pictured holding the first copy of the new reprint (from the original 1916 edition), *Phineas F. Bresee: A Prince in Israel*. The book was presented to Horace and Esther Bresee at the Los Angeles First Church. Horace is a grandson of Dr. Bresee. This book contains a citation wherein the publishing house recognizes the great contribution to the heritage of the Church of the Nazarene by the Bresee family.



## EVANGELIST'S SLATES

- ABNEY, JOHN:** Gainesville, GA (First), Oct. 2-4; Kingsport, TN (First), Oct. 20-25
- ARMSTRONG, DONNELL:** Welch, WV, Oct. 6-11; Margate, MD (Glen Burnie), Oct. 20-25
- ARMSTRONGS, LEON, LINDA, AND FAMILY:** Fredericksburg, VA, Oct. 6-11; Rocky Mount, NC, Oct. 13-18; Robertsdale, AL, Oct. 20-25; Manassas, VA, Oct. 30-Nov. 1
- ATKINSON, DEAN & PAT & FAMILY:** Hollis, OK, Sept. 28-Oct. 4
- ATTIG, WALTER:** Decatur, IL (Oak Grove), Oct. 11-18; Fairview Heights, IL, Oct. 20-25
- \*BAGGETT, DALLAS:** Amelia, OH, Oct. 6-11; Somerset, KY, Oct. 13-18
- BAKER, RICHARD C.:** Burnwell, WV, Oct. 6-11; Summersville, WV (First), Oct. 13-18; Adington, VA (First), Oct. 20-25; Bishopville, SC, Oct. 27-Nov. 1
- BALDWIN, DEAN:** Gladstone, MO, Oct. 6-11; Larimore, ND, Oct. 27-Nov. 1
- \*BALLARD, DON:** Louisville, KY (First), Oct. 6-11; Tuscaloosa, AL (Holtz Heights), Oct. 14-18; Reserved, Oct. 20-25; Cullman, AL (First), Oct. 27-Nov. 1
- BEARDEN, LES:** Man, WV (First), Sept. 29-Oct. 4; South Charleston, WV (Davis Creek), Oct. 7-11; Oskaloosa, IA (First), Oct. 14-18; Arlington, VA (First), Oct. 20-25; Bloomington, IN (First), Oct. 27-Nov. 1
- BELL, JAMES & JEAN:** Sulphur Springs, TX (First), Oct. 7-11; Houston, TX (Northshore), Oct. 14-18; Shreveport, LA (Werner Park), Oct. 21-25; Pana, IL, Oct. 28-Nov. 1
- BENDER EVANGELISTIC PARTY:** Mexico, MO, Oct. 2-11; Columbus, OH (Frank Road), Oct. 16-25; Zanesville, OH (First), Oct. 30-Nov. 1
- BLUE, DAVE AND DANA:** Clarksville, TN (Memorial Drive), Oct. 8-11; Oskaloosa, IA, Oct. 14-18; South Charleston, WV (First), Oct. 21-25; Charleston, WV (First), Oct. 27-Nov. 1
- BLTYHE, ELLIS:** Fort Lauderdale, FL (First), Oct. 9-11; Jacksonville Beaches, FL (First), Oct. 13-18; West Columbia, SC, Oct. 20-25
- BOCK, DON:** Columbus, OH (Warren Ave.), Oct. 6-11; North Jackson, OH, Oct. 27-Nov. 1
- BOND, GARY & BETH:** Weirton, WV (First), Oct. 6-11; Willard, OH, Oct. 13-18; Tiffin, OH, Oct. 20-25; Ashland, KY (First), Oct. 27-Nov. 1
- BREWINGTON, JANE:** Chowchilla, CA, Oct. 6-11; Chico, CA (First), Oct. 13-18; Blythe, CA, Oct. 20-25; Kendallville, IN, Oct. 27-Nov. 8
- BRISCOE FAMILY, JOHN:** Hoisington, KS, Oct. 6-11; Plainville, KS, Oct. 13-25
- BROOKS, GERALD & JUNE:** Terre Haute, IN (Southside), Oct. 6-11; Mattoon, IL (Eastside), Oct. 13-18; Larned, KS (First), Oct. 20-25; Reserved, Oct. 27-Nov. 1
- BROOKS, STANLEY E.:** Wallingford, CT, Oct. 21-25
- BROWN, ROGER:** Fostoria, OH (First), Oct. 6-11; Concerts in Missouri, Oct. 13-15; Granite City, IL (Meth.), Oct. 18; O'Fallon, MO (First), Oct. 20-25; Bloomington, IN (First), Oct. 27-Nov. 1
- BUCKLES-BURKE EVANGELISTIC TEAM:** Doylestown, OH, Oct. 6-11; Piqua, OH, Oct. 13-18; Newton, IA, Oct. 20-25; Iowa City, IA, Oct. 27-Nov. 1
- BUDD, JAY:** Delaware, OH, Oct. 25-Nov. 1
- BURCH, SAM:** Yuma, CO, Oct. 6-11; Cody, WY, Oct. 13-18; Burlington, CO, Oct. 20-25; Fort Scott, KS, Oct. 27-Nov. 1
- BURKHALTER, PAT:** Moss, MS (Bethlehem), Oct. 20-25; Jacksonville, TX (Mount Hope) Oct. 27-Nov. 1
- CANEN, DAVID:** Savannah, GA (Eastside), Oct. 5-11; Jonesboro, GA, Oct. 13-18; Richmond, MO, Oct. 20-25
- CAYTON, JOHN:** Ryot, PA, Oct. 6-11; O'Leary, P.E.I., Canada, Oct. 22-Nov. 1
- CHAPMAN, W. EMERSON:** Burlington, KS, Oct. 6-11
- CHASE, FRANK:** Copley, OH, Oct. 6-11; Columbus, IN (First), Oct. 14-18; Wichita, KS (Park City), Oct. 27-Nov. 1
- CHRISTNER, JACK:** Jefferson, PA, Oct. 6-11; Hamburg, NY, Oct. 13-18; West Mifflin, PA (Pittsburgh Terrace), Oct. 20-25; North Huntingdon, PA (Circleville), Oct. 27-Nov. 1
- COLLINS, LUTHER:** Tulsa, OK (First), Oct. 6-11; St. Johns, MI, Oct. 13-18; Reserved, Oct. 20-25; Sundre, Alberta, Oct. 27-Nov. 1
- CONE, ANDREW:** Anzer, CA (Community), Oct. 4-11; Covina, CA, Oct. 14-18; LaPuente, CA, Oct. 20-25
- COOK, DAVID & EVA:** Osgood, IN, Oct. 5-11; Liberty, IN, Oct. 13-18; Martinsville, IN (Willow Grove), Oct. 25; Indianapolis, IN (Northside), Oct. 28-Nov. 1
- COX, CURTIS:** Monroe, LA (First), Oct. 27-Nov. 1
- CRANDALL, VERNON & BARBARA:** DeMotte, IN (First), Oct. 6-11; Peru, IN, Oct. 13-18; Gary, IN (Aetna), Oct. 20-25; Hoopston, IL (Westside), Oct. 27-Nov. 1
- CRANE, BILLY:** Shadyside, OH, Oct. 6-11; New Martinsville, WV, Oct. 13-18; Newton Falls, OH, Oct. 20-25; Canton, OH (Calvary), Oct. 27-Nov. 1
- \*CREWS, H. F.:** Hamlin, TX, Oct. 20-25
- CULBERTSON, BERNIE:** Walla Walla, WA (Aldersgate), Oct. 6-11; Cheshire, OR, Oct. 20-25; Grangeville, ID (First), Oct. 27-Nov. 1
- DARNELL, H. E.:** Lexington, NC (Health), Oct. 1-11; Graham, NC, Oct. 15-25; Northville, NY, Oct. 29-Nov. 8
- DAWS, LEONARD:** Dayton, OH (Grace), Oct. 6-11; Lebanon, TN (Westview), Oct. 13-18; Cincinnati, OH (Goshen), Oct. 19-25
- DELL, JIMMY:** Carlsbad, NM (First), Oct. 1-4; Glendale, AZ (First), Oct. 10-14; Tucson, AZ (First), Oct. 15-18; North Long Beach, CA, Oct. 22-25; Gallup, NM, Oct. 28-Nov. 1
- DENNISON, MARVIN:** Windsor, Nova Scotia, Sept. 29-Oct. 4; Dartmouth, Nova Scotia, Oct. 6-11
- DIXON, GEORGE & CHARLOTTE:** Frostburg, MD (Moscow), Oct. 7-11; Denton, MD, Oct. 14-18; Waverly, NY, Oct. 21-25; East Patchogue, NY, Oct. 26-30
- DOROUGH, JAMES:** Many, LA, Oct. 6-11; Walters, OK, Oct. 13-18; Richland Center, WI, Oct. 20-25; Ottumwa, IA (Northside), Oct. 27-Nov. 1
- DUNMIRE, RALPH & JOANN:** Nashville, TN (Trinity), Oct. 6-11; Shelbyville, IN (First), Oct. 13-18; Chattanooga, TN (East Ridge), Oct. 20-25; Southside, TN (Grays Chapel) Oct. 27-Nov. 1
- DUNN, DON:** Cumberland, MD, Oct. 6-11
- EASTMAN, RICK:** Racine, WI (Taylor Avenue), Oct. 6-11; Hot Springs, AR (Richards Street), Oct. 14-18; St. Petersburg, FL (First), Oct. 27-Nov. 1
- ECKLEY, LYLE:** Havana, IL (First), Oct. 6-11; Rockford, IL (Parkside), Oct. 13-18; Waynesville, MO, Oct. 20-25
- ERICKSON, WILLIAM A.:** Brentwood, TN (New Hope Comm.), Oct. 6-11; Charleston, WV (Southeast), Oct. 13-18; Freemont, CA (First), Oct. 20-25
- ESSELBURN, BUD (THE KINGS MESSENGERS):** Rimersburg, PA (Wes.), Oct. 1; Titusville, PA (First), Oct. 2; West Chazy, NY (Wes.), Oct. 6-11; Mooers, NY (Wes.), Oct. 13-18; Freedom, PA, Oct. 20-25
- EVERMAN, RUSSELL WAYNE:** Irvine, KY, Oct. 5-11; North Middletown, KY, Oct. 12-18; Corbin, KY, Oct. 20-25
- FELTER, JASON:** Shawmut, AL (First), Sept. 29-Oct. 4; Chillicothe, OH (CCCU), Oct. 6-11; Jackson, OH, Oct. 15-25
- FILES & ADAMS:** North Field, NJ, Oct. 6-11
- FISHER, WILLIAM:** Newton, KS (First), Sept. 29-Oct. 4; Overland, MO, Oct. 6-11; Springfield, IL (First), Oct. 13-18; St. Louis, MO (Bridgeton), Oct. 20-25; Oak Hill, WV, Oct. 27-Nov. 1
- FLORENCE, ERNEST:** Hammond, IN (Black Oak), Oct. 6-11; Plainfield, IN (Keystone), Oct. 13-18; Lebanon, IN, Oct. 20-25
- FORTNER, ROBERT:** Stinesville, IN, Oct. 6-11; Parkersburg, IL (United Meth.), Oct. 13-18; Dublin, GA, Oct. 20-25; Oakland City, IN, Oct. 27-Nov. 1
- FRODGE, HAROLD:** Florien, LA, Oct. 6-12; Covington, IN, Oct. 13-18; Texarkana, AR, Oct. 20-25; Griggsville, IL, Oct. 28-Nov. 1
- FULLER, J. D.:** Versailles, KY, Oct. 13-18
- GANTHROP, WAYLAND:** Merrifield, MN (Community), Oct. 6-11; Grand Rapids, MN, Oct. 13-18; Lenoir City, TN (First), Oct. 20-25; Greens Fork, IN, Oct. 27-Nov. 1
- GLENDENNING, PAUL & BOBBIE:** Birmingham, LA (Free Meth.), Oct. 6-11; Winchester, KY (Wes.), Oct. 13-18; Freeman, SD, Oct. 25-Nov. 1
- GORMAN, HUGH:** Shelbourne, Ontario (Grace), Oct. 6-11; Newmarket, Ontario, Oct. 13-18; Lynden, Ontario (Orkey), Oct. 20-25; Pickering, Ontario (Altona Road), Oct. 27-Nov. 1
- GORMANS, THE SINGING:** Booneville, IN (First), Oct. 17-18; Mitchell, IN (First), Oct. 27-Nov. 1
- GRACE, GEORGE:** Galena, KS (Parkhill), Oct. 4-11; Gothenburg, NE, Oct. 13-18; Arnold, NE, Oct. 20-24
- GRAY, BOB & BECKY:** Mustang, OK, Sept. 29-Oct. 4; Bethany, OK (Calvary), Oct. 6-11; Lawton, OK (Lawton Heights), Oct. 27-Nov. 1
- GRAY, DAVID AND REBECCA:** Mifflinburg, PA (First), Oct. 6-11; Fort Wayne, IN (Lake Ave.) Oct. 18; Auburn, IN, Oct. 25; Scottsdale, PA (First), Oct. 27-Nov. 1
- GREEN, JIM & ROSEMARY:** Wooster, OH (First), Oct. 13-18; Columbus, OH (Whitehall), Oct. 27-Nov. 1
- GRIMES, BILLY:** Mount Pleasant, TX, Oct. 6-11; Dumas, TX, Oct. 13-18; El Dorado, AR (First), Oct. 20-25
- GRINDLEY, GERALD & JANICE:** Muskegon, MI (First), Oct. 6-11; Anderson, IN (First), Oct. 13-18; Roanoke, VA (East Gate), Oct. 20-25; Friendly, MD (Trinity), Oct. 27-Nov. 1
- GROVES, C. WILLIAM:** Georgetown, IN, Oct. 6-11; Chesapeake, OH, Oct. 13-18; Williamsport, OH (Darbyville), Oct. 27-Nov. 1
- HAAS, WAYNE & JUNE:** Fort Trenchard, IN, Sept. 29-Oct. 4; Lawrence, IN, Oct. 6-11; Muncie, IN (Wes.), Oct. 13-18; Greencastle, IN, Oct. 20-25
- HAIL, D. F.:** Lowville, NY, Oct. 13-18; Warren, OH (First), Oct. 20-25; Barberton, OH (First), Oct. 27-Nov. 1
- HAINES, GARY:** Council Bluffs, IA (First), Oct. 2-4; York, NE (First), Oct. 9-11; Beckley, WV (First), Oct. 13-18; Nashville, TN (Inglewood), Oct. 20-25; New Castle, OK (First), Oct. 20-Nov. 1
- HALL, CARL:** Wichita, KS (Eastridge), Oct. 7-11; South Bend, IN (First), Oct. 13-18; Nashville, TN (Grace), Oct. 20-25; Charleston, SC (Dorchester RD), Oct. 27-Nov. 1
- \*HANCE, RAY:** Muldrow, OK, Oct. 6-11; Midwest City, OK (Chapman Memorial), Oct. 20-25
- HANCOCK, BOYD:** Lynchburg, VA (First), Oct. 6-11; Elmira, NY (First), Oct. 13-18; Henrietta, NY (First), Oct. 20-25; Mundelin, IL, Oct. 27-Nov. 1
- HANSON, BRIAN & CHERYL:** Wichita, KS (Linwood), Oct. 7-11; Mishawaka, IN, Oct. 20-25
- \*HARROLD, JOHN:** Fithian, IL (First), Oct. 6-11; Peoria, IL (Golden Acres), Oct. 20-25
- HEASLEY, JIMMY & FERN:** Derby, KS, Oct. 13-18
- HENDERSON, LATTIE:** High Point, NC (United Meth.), Oct. 5-11; Lewisburg, TN, Oct. 12-18; Corpus Christi, TX (Salvation Army), Oct. 19-25; Mount Morris, MI, Oct. 31-Nov. 1
- HILL, HOWARD:** Sarasota, FL (First), Oct. 20-25
- HILL, RON AND CHARLENE:** Bergholz, OH (Wolf Run), Oct. 4-11; Irondale, OH, Oct. 12-18; Brockton, NY (First), Oct. 20-Nov. 1
- HOLLOWELL, JERRY:** Vernon, TX (First), Oct. 13-18
- HORNE, ROGER & BECKY:** Clarkton, MO (Lone Oak Bapt.), Oct. 1-4; Richmond, VA (Southside), Oct. 11; Reserved, Oct. 22-25
- HOWARD, RICHARD:** St. Louis, MO (Bridgeton), Oct. 7-11; Ravenna, OH (First), Oct. 13-18; Mount Vernon, OH (Lakeholm), Oct. 20-25
- HUBBART, LEONARD:** Aledo, IL, Sept. 29-Oct. 4
- JACKSON, CHUCK & MARY:** Mattoon, IL (First), Oct. 1-4; Dakota District (Home Missions Tour), Oct. 7-18; Shawnee, OK (First), Oct. 21-25; Selma, AL (First), Oct. 27-Nov. 1
- JACKSON, PAUL & TRISH:** Bradford, PA (Bolivar), Oct. 6-11; Homer City, PA (First), Oct. 13-18; Waltersburg, PA (First), Oct. 20-25; Waynesburg, PA (First), Oct. 27-Nov. 1
- JANTZ, CALVIN & MARJORIE:** Bradley, IL (First), Oct. 6-11; East Alton, IL (Rosewood Heights), Oct. 13-18; New Albany, IN (Eastside), Oct. 20-25; Maysville, KY (First), Oct. 27-Nov. 1
- JAYMES, RICHARD:** Columbus, OH, Oct. 6-11; Dayton, OH (West Acres), Oct. 20-25
- JOHNSON, RON:** Concerts in Alberta, Oct. 1-4; Concerts in Washington, Idaho, Oct. 11-18; Bel Air, MD, Oct. 21-25; Baltimore, MD (First), Oct. 27-Nov. 1
- \*KNIGHT, JOHN:** Dexter, MO (First), Oct. 6-11; Fort Myers, FL (First), Oct. 13-18; Winfield, KS (First), Oct. 20-25; Altus, OK (First), Oct. 27-Nov. 1
- \*KRATZER, RAYMOND:** Coquille, OR, Oct. 14-20; Maine Dist. Pastors' Retreat, Oct. 19-21; Bel Air, MD, Oct. 21-25; Baltimore, MD (First), Oct. 27-Nov. 1
- LAING, GERALD:** Garret, IN, Oct. 6-11
- \*LAKE, GEORGE:** Burlington, IA (First), Sept. 29-Oct. 4; Batesville, AR (First), Oct. 6-11; Crowley, LA (Ebenezer), Oct. 13-18; Reserved, Oct. 20-25; Pineville, LA (Coalfax), Oct. 27-Nov. 1
- LASSELL, RAY & JAN:** Paris, IL, Oct. 6-11; Marshall, IL, Oct. 13-18; Yorktown, IN, Oct. 20-25; Seymour, IN (Peter's Switch), Oct. 27-Nov. 1
- LAWSON, WAYNE:** Soldotna, AK, Oct. 4-11; Homer, AK, Oct. 13-18; Nome, AK, Oct. 20-25; Kodiak, AK, Oct. 27-Nov. 1
- LAXSON, WALLY & GINGER:** Tuscaloosa, AL (Southside), Oct. 2-4; Nashville, TN (First), Oct. 7-11; Kankakee, IL (First), Oct. 14-18; Nashville, TN (Grace), Oct. 20-25; Albuquerque, NM, Oct. 28-Nov. 1
- LECKRONE, LARRY:** Nashville, TN (McClurkin), Oct. 6-11; Alexandria, LA, Oct. 13-18; Lake City, FL, Oct. 20-25; Monroe, NC, Oct. 27-Nov. 1
- LECRONE, JON & BETH:** Springfield, IL (South), Oct. 6-11; Ottawa, IL (Southside), Oct. 13-18; Concerts in Oklahoma and California, Oct. 20-25; Central California S.A.M. Retreat, Oct. 26-30

LEONARD, J. C.: Greenfield, IN (Springtown), Oct. 6-11; West Plains, MO, Oct. 13-18; Creston, IA, Oct. 20-25

LESTER, FRED R.: Reserved, Oct. 4-11; Westminster, CA (Midway City), Oct. 11-18; Reserved, Oct. 19-25; Oakland, CA (Peniel Rescue Mission, Interdenominational), Oct. 26-Nov. 1

LIDDELL, P. L.: Birdsboro, PA, Oct. 6-11; Seneca, PA (Evangelical Cong.), Oct. 13-18; Oak Park, IL, Oct. 20-25; Lansing, IL, Oct. 27-Nov. 1

LOWN, ALBERT: Washington, D.C., Oct. 21-25; New Brighton, PA, Oct. 27-Nov. 1

MANLEY, STEPHEN: West Chester, OH (Pisgah Comm.), Oct. 6-11; Roanoke, VA (Garden City), Oct. 13-18; Roanoke, VA (East Gate), Oct. 20-25; Mechanicsville, VA (First), Oct. 27-Nov. 1

MANN, L. THURL & MARY KAY: North Little Rock, AR (First), Oct. 7-11; Searcy, AR, Oct. 13-18; Woodward, OK (First), Oct. 21-25; Norman, OK (First), Oct. 28-Nov. 1

\*MARLIN, BEN: Reserved, Oct. 6-16; Fort Lauderdale, FL (First), Oct. 16-18

MARTIN, W. DALE: Wheelersburg, OH (First), Oct. 6-11; Fairmont, WV (Central), Oct. 13-18; Catlettsburg, KY (Southside), Oct. 20-25; Moultrie, GA (First), Oct. 27-Nov. 1

MATTER, DAN & ANN: Dunkirk, IN, Oct. 5-11; New Hampshire, OH, Oct. 20-25; Forest, OH (CCCU), Oct. 30-Nov. 1

MAX, HOMER: Des Moines, IA, Oct. 13-18; Rock Hill, SC, Oct. 26-Nov. 1

MAYO, CLIFFORD: Hennessey, OK, Oct. 13-18

McCUITION, MARK AND PATRICIA: Monroeville, AL, Oct. 6-11; Cincinnati, OH (Montana Ave.), Oct. 13-18; Bloomsburg, PA, Oct. 27-Nov. 1

McWHIRTER, G. STUART: Wooster, OH (First), Oct. 13-18; Champaign, IL, Oct. 21-25

MELVIN, DOLORES: DeQueen, AR, Oct. 5-11; Idabel, OK, Oct. 13-18; Okemos, MI, Oct. 22-25

MEREDITH, DWIGHT & NORMA JEAN: Larned, KS, Oct. 20-25; Hutchinson, KS (Peniel), Oct. 27-Nov. 1

MEYER, BOB & BARBARA, DYNAMICS OF SPIRITUAL GROWTH: Yuma, AZ (Grace), Oct. 4-8; Phoenix, AZ (Orangewood), Oct. 11-15; Mesa, AZ (First), Oct. 18-22; Chandler, AZ, Oct. 25-29

MICKEY, BOB: Macon, MO, Oct. 6-11; Chickasha, OK, Oct. 13-18; Meridian, MS, Oct. 27-Nov. 1

MILHUFF, CHUCK: Denver, CO (First), Oct. 11-18; Defiance, OH, Oct. 25-Nov. 1

MINGELDORFF, WALTER: Donalsonville, GA (First), Oct. 6-11; Tallahassee, FL (First), Oct. 13-18; Lake City, FL (First), Oct. 20-25

MIRACLE, WALTER: Manchester, OH (First), Oct. 6-11; Lexington, KY (Calvary), Oct. 13-18; Indianapolis, IN (South Irvington), Oct. 20-25; Fort Dodge, IA (First), Oct. 27-Nov. 1

MOORE, NORMAN: Vancouver, WA (Central), Oct. 4-11; Indio, CA, Oct. 13-18; South Gate, CA, Oct. 21-25; Norco, CA, Oct. 28-Nov. 1

MOORMAN, GAIL C.: Indianapolis, IN (Keystone), Oct. 6-11

MORRIS, CLYDE: Danville, IL (Northside), Oct. 6-11; Hebron, OH, Oct. 13-18; Quick, WV, Oct. 25-Nov. 1

MOYER, BRANCE: Garnett, KS (First), Oct. 6-11; Gilman, IL (First), Oct. 13-18; Lamar, MO (First), Oct. 20-25; Wichita Falls, TX (University Park), Oct. 30-Nov. 1

MULLEN, DEVERNE: Melrose, MA, Oct. 6-11; Toronto, Ontario (Emmanuel), Oct. 18; Potsdam, NY, Oct. 20-26

NEFF, LARRY & PAT: Warren, MI (Warren Woods), Oct. 7-11; Roanoke, VA, Oct. 13-18; Chattanooga, TN (First), Oct. 20-25; Bluefield, WV, Oct. 27-Nov. 1

\*NEUSCHWANGER, ALBERT: Trenton, MO (First), Oct. 6-11

OVERTON, WILLIAM: Ossian, IN, Oct. 6-11; Woodfield, OH, Oct. 13-18; Rochester, NY (Grace), Oct. 20-25; Kingston, NY, Oct. 27-Nov. 1

PALMER, JAMES: New Castle, IN (Westview), Oct. 6-11; Columbus, IN (Holiness), Oct. 11-18; Brosley, MO, Oct. 19-25; Greenwood, IN (First), Oct. 27-Nov. 1

PASSMORE EVANGELISTIC PARTY: Shenandoah, IA, Oct. 6-11; Centralia, IL, Oct. 13-18; Lincoln, IL, Oct. 20-25; Shelby, OH, Oct. 27-Nov. 1

PERDUE, NELSON: Fostoria, OH, Oct. 6-11; Galesburg, IL, Oct. 13-18; Chattanooga, TN, Oct. 20-25; Moundsville, WV (Indoor Camp Mtg.), Oct. 28-Nov. 1

PFEIFER, DON: Oklahoma City, OK (Meridian Park), Oct. 8-11; Bethany, OK (Williams Memorial), Oct. 13-18; Topeka, KS, Oct. 20-25; Lawrence, KS (First), Oct. 27-Nov. 1

PHILLIPS, W. D.: Reynoldsburg, OH, Oct. 5-11

PORTER, JOHN & PATSY: Bristow, OK (First), Oct. 6-11; Jonesboro, AR (Forest Home), Oct. 13-18; Chattanooga, TN (East Ridge), Oct. 20-25; Jamestown, TN (Pine Haven), Oct. 27-Nov. 1

QUALLS, PAUL: Nebo, IL (First), Sept. 29-Oct. 4; Springfield, OH (Erie Ave.), Oct. 6-11; Louisville, KY (Farmdale), Oct. 13-18

\*READER, GEORGE H. D.: Dupo, IL, Oct. 18-25

REDD, GARY: Little Rock, AR (Calvary), Oct. 21-25

RITCHIE, L. L.: Nashville, TN (Trinity), Oct. 6-11; Mount Pleasant, IA, Oct. 20-25; Dayton, KY, Oct. 26-Nov. 1

ROBINSON, TED: Cottage Grove, OR, Oct. 6-18; Georgetown, IL, Oct. 20-25; Clinton, IA (First), Oct. 27-Nov. 1

ROSS, MICHAEL: Brandon, FL, Oct. 6-11; East Liverpool, OH (Calcutta), Oct. 13-18; Fort Lauderdale, FL (First), Oct. 23-25; Sarasota, FL (Swift Road), Oct. 28-Nov. 1

ROTH, RON: Elizabethton, TN, Sept. 29-Oct. 4; Columbia, KY (First), Oct. 6-11; Taylorville, IL (First), Oct. 13-18; Baxter Springs, KS (First), Oct. 20-25; Columbia, MO (First), Oct. 27-Nov. 1

SCARLETT, DON: Index, KY (Community), Oct. 13-18

SCHOONOVER, MODIE: Williamsburg, IN, Oct. 6-11; Sciotoville, OH, Oct. 13-18; Shpshewana, IN, Oct. 27-Nov. 1

SHALLEY, JIM: Sylvania, OH, Oct. 19-25; Grand Haven, MI, Oct. 26-Nov. 1

SHANK, JOHN: Gregory, MI, Oct. 6-11; Tilden, IL, Oct. 13-18; Danville, IL (Southside), Oct. 20-25; El Paso, IL, Oct. 27-Nov. 1

SMITH, CHARLES HASTINGS: Portsmouth, OH (First), Oct. 6-11; Conroe, TX (First), Oct. 21-25; Phoenix, AZ (Billmore), Oct. 28-Nov. 1

SMITH, DENNIS: Farmer City, IL, Oct. 6-11; Cincinnati, OH (Blue Ash), Oct. 13-18; Hacienda Heights, CA, Oct. 28-Nov. 1

SMITH, DUANE: Connersville, IN (Gortner Memorial), Oct. 6-11; Confluence, PA, Oct. 13-18; Kittanning, PA (First), Oct. 20-25; Knox, PA, Oct. 27-Nov. 1

SMITH, HAROLD & ORPHA: Laingsburg, MI, Oct. 20-25; Sumner, MI (Center), Oct. 27-Nov. 1

SMITH, OTTIS & MARGUERITE: Anderson, IN (Columbus Ave.), Sept. 29-Oct. 4; Leesburg, VA, Oct. 6-11; Ephrata, PA, Oct. 13-18; Maiden, MA, Oct. 20-25; Waltham, MA (Community), Oct. 27-Nov. 1

SPROWLS, EARL: Pensacola, FL (Enslay), Oct. 13-18; Tampa, FL (Town & Country), Oct. 20-25; Tampa, FL (Grace), Oct. 27-Nov. 1

STANTON, TED & DONNA: Gainesville, FL (Trinity), Sept. 29-Oct. 4

STEGALL, DAVID: Plano, TX, Oct. 6-11; Denison, TX (First), Oct. 13-18; Fort Morgan, CO, Oct. 20-25; Del City, OK (First), Oct. 27-Nov. 1

STEVENSON, GEORGE: Muskegon, MI (First), Oct. 6-11; Grand Rapids, MI (Fuller Ave.), Oct. 13-18; Erie, PA (First), Oct. 20-25; Cape Elizabeth, ME, Oct. 27-Nov. 1

\*STEWART, PAUL: Lakeland, FL (First), Oct. 6-11

STOUT, PHILLIP: Syracuse, IN, Oct. 6-11; Newark, OH (Central), Oct. 13-18; West Bend, WI, Oct. 20-25

STREET, DAVID: Elkton, KY, Oct. 6-11; St. David, IL, Oct. 13-18; Terre Haute, IN (First), Oct. 20-25; Roanoke, AL, Oct. 27-Nov. 1

SWANSON, ROBERT: Lafayette, LA, Sept. 29-Oct. 4; Fairfield, IA, Oct. 6-11; Kingman, KS, Oct. 27-Nov. 1

SWEENEY, ROGER & EULETA: Kurtz, IN, Sept. 29-Oct. 4; Elkton, KY, Oct. 6-11; Versailles, KY, Oct. 13-18

TAYLOR, EMMETT: Madill, OK, Oct. 6-11; Cenchræ, LA, Oct. 13-18; Springfield, MO (Scenic Dr.), Oct. 20-25; Jonesboro, AR (First), Oct. 27-Nov. 1

\*TAYLOR, MENDELL: Farnam, NE (First), Oct. 6-11; Oklahoma City, OK (Crown Heights), Oct. 13-18

TAYLOR, ROBERT: Elkins, WV, Oct. 6-11; St. Albans, WV, Oct. 13-18; Woodbridge, VA, Oct. 21-25; Vienna, VA (First), Oct. 27-Nov. 1

THOMAS, J. MELTON: Kenner, LA (First), Sept. 29-Oct. 4; Natchitoches, LA, Oct. 6-11; Dayton, OH (Northridge), Oct. 13-18; Maynard, MA, Oct. 23-25; Upper Montclair, (Trinity), Oct. 29-Nov. 1

TOEPFER, PAUL: Okemos, MI, Oct. 5-11; Lansing, MI (Kendon Dr.), Oct. 12-18; Reed City, MI, Oct. 19-25

TRIPP, HOWARD: Indianapolis, IN (Eagledale), Oct. 6-11; Shelbyville, IN (First), Oct. 13-18; Lenoir City, TN (White Wing), Oct. 20-25

TRISSEL, PAUL & MARY: Berne, IN (First), Oct. 13-18

TUCKER, BILL & JEANETTE: Ionia, MI (First), Oct. 6-11; Bay City, MI (Faith), Oct. 13-18; Alpena, MI, Oct. 20-25; Cadillac, MI (Cherry Grove), Oct. 27-Nov. 1

TUCKER, RALPH: Mangum, OK, Oct. 13-18; Indianapolis, IN (Central), Oct. 20-25

VARIAN, BILL: Mifflinsburg, PA (First), Oct. 6-11; Amarillo, TX (San Jacinto), Oct. 20-25; Warren, OH (Bolingdale), Oct. 27-Nov. 1

WADE, KENNETH & CAROL: Chrisman, IL, Oct. 6-11; Mount Blanchard, OH, Oct. 13-18; Battle Creek, MI (Morgan Road), Oct. 20-25; Fairview, OK (Cedar Springs), Oct. 28-Nov. 1

WALKER, LAWRENCE: Dover, OH, Oct. 5-11; Reserved, Oct. 20-31

WALLACE, J. O.: Warner Robbins, GA (First), Oct. 13-18

\*WARD, LLOYD & GERTRUDE: Manchester, GA (First), Sept. 27-Oct. 4; Nashville, TN (Radnor), Oct. 6-11; Ann Arbor, MI (First), Oct. 13-18; Danville, IL (Oaklawn), Oct. 20-25; Fremont, OH, Oct. 27-Nov. 1

WELCH, DARLENE: Louisville, KY (First), Oct. 25

WELLS, LINARD: Granbury, TX, Sept. 29-Oct. 4; Henderson, TX, Oct. 6-11; Fort Worth, TX (Haltom City), Oct. 13-18; Grand Prairie, TX (First), Oct. 20-25; Barnsdall, OK, Oct. 27-Nov. 1

WEST, EDNA: Salisbury, NC (First), Oct. 11-18

\*WHITED, CURTIS: Sarcoux, MO, Oct. 6-11

WILLIAMS, LARRY AND LYNNE: Garland, TX, Oct. 6-11; Blackwell, OK (Southside), Oct. 13-18; Temple, TX (Trinity), Oct. 21-25

WILLIAMS, LAWRENCE: Pine Bluff, AR (Oak Park), Oct. 6-11; Orbisonia, PA, Oct. 15-25; McConnellstown, PA, Oct. 26-Nov. 1

WISEHART, LENNY & JOY: Dayton, OH (Parkview), Oct. 6-11; Trenton, OH, Oct. 13-18; Mount Sterling, OH, Oct. 20-25

WOODWARD, S. OREN: Churubusco, IN, Oct. 6-11; St. Paris, OH, Oct. 13-18; London, OH, Oct. 20-25; Fort Wayne, IN (First), Oct. 27-Nov. 1

\*WOOLMAN, J. L.: Oklahoma City, OK (Capitol Hill), Oct. 26-Nov. 1

WYLLIE, CHARLES: Fargo, OK (First), Oct. 6-11; Erick, OK (First), Oct. 13-18; Council Bluffs, IA (Emanuel), Oct. 27-Nov. 1

WYRICK, DENNIS: Harrisonburg, VA, Oct. 6-11; Pontiac, MI (Hillcrest), Oct. 20-25; Buchanan, MI, Oct. 27-Nov. 1

\*Receive ministerial pension but are actively engaged in the field of evangelism.



## Book Briefs

### ORDER COUPON

See page 17 for description.

Please send \_\_\_\_\_ copies of

**COUNT YOUR PEARLS**

by **Esther Lunsford**

at **\$2.25** each to:

64 pages  
Paper

Date \_\_\_\_\_, 1981

Name \_\_\_\_\_

Street \_\_\_\_\_

City \_\_\_\_\_

State/Province \_\_\_\_\_ Zip \_\_\_\_\_

**CHECK** or **MONEY ORDER** Enclosed \$ \_\_\_\_\_

**CHARGE** (30-day) TO:  Personal \_\_\_\_\_ other account \_\_\_\_\_

**Clip and Mail TODAY!**

**NAZARENE PUBLISHING HOUSE** • Post Office Box 527, Kansas City, Missouri 64141

# FOR THE RECORD

## DISTRICT SUPERINTENDENTS

### AFRICA

**MALAWI CENTRAL**—Kalitera, P.O. Box 302, Lilongwe, Malawi, Africa

## NEW SPANISH EWS PUBLICATIONS

Coming in December 1981! . . . La Palabra Eterna (Spanish translation of the Enduring Word Series Sunday School lessons for use in Spanish and bilingual churches in the U.S.A.).

*Maestro De Adultos (Adult Teacher)* contains the lesson commentary and a column of teacher's helps, as well as articles dealing with Hispanics' minority problems from a Christian perspective.

*El Estudiante Bíblico (Adult Student)* contains the lesson commentary and inspirational and devotional items.

These new publications will coincide with the English seasonal quarters. The first one, the winter issue (December/January/February, 1981-82) may be ordered now.

Send all orders to:

CASA NAZARENA  
DE PUBLICACIONES  
P.O. Box 527  
Kansas City, MO 64141

**MALAWI SOUTH**—Albert Mphamba, P.O. Box 136, Zomba, Malawi, Africa

**MOÇAMBIQUE LIMPOPO**—Simeon Manhique, c/o Frank Howie, P.O. Box 331, Florida 1710, Transvaal, Republic of South Africa

**MOÇAMBIQUE MAPUTO**—Solomon Macia (same as above)

**MOÇAMBIQUE MAVENGANE**—Silvano Nuvunga (same as above)

**MOÇAMBIQUE TAVANE**—Benjamin Langa (same as above)

**MOÇAMBIQUE TETE**—Marcelino Rupia (same as above)

## NUEVAS PUBLICACIONES DE SLPE

¡Comenzando en diciembre de 1981! . . . aparecerán dos nuevas revistas de la serie La Palabra Eterna (traducción hispana de Enduring Word Series, curso de estudios de escuela dominical para iglesias hispanas y bilingües de E.U.A.).

*Maestro De Adultos* contiene el comentario de la lección y una columna de sugerencias para el maestro, así como artículos sobre las minorías hispanas de este país y sus problemas desde una perspectiva cristiana.

*El Estudiante Bíblico* contiene el comentario de la lección, así como artículos devocionales y de inspiración.

Estas nuevas publicaciones coincidirán con las de inglés (*Adult Teacher* y *Adult Student*) que se publican trimestralmente. El primer número (diciembre/enero/febrero 81-82) ya está a la venta. Pídale a:

CASA NAZARENA  
DE PUBLICACIONES  
P.O. Box 527  
Kansas City, MO 64141

**REPUBLIC OF CAPE VERDE**—Gilberto Evora, Caixa Postal 96, Praia, Republic of Cape Verde

**REPUBLIC OF SOUTH AFRICA EUROPEAN**—Richard Zanner, P.O. Box 44, Florida, Transvaal, 1710, Republic of South Africa

**REPUBLIC OF SOUTH AFRICA NORTH, BLOUBERG**—D. Mokebe, Private Bag 7412, Pietersburg, Tvl. 0700, Republic of South Africa

**REPUBLIC OF SOUTH AFRICA NORTH, E. BOPHUTHATSWANA**—Wilton C. Maeneta, P.O. Box 32, Mapopane 0100, Bophuthatswana, Republic of South Africa

**REPUBLIC OF SOUTH AFRICA NORTH, EASTERN**—Hannibal Sebati, P.O. Box 186, Acornhoek, E. Transvaal, 1360 Republic of South Africa

**REPUBLIC OF SOUTH AFRICA NORTH, NORTHEAST**—R. M. Rebese, P.O. Box 160, Letaba, Transvaal 0870, Republic of South Africa

**REPUBLIC OF SOUTH AFRICA NORTH, SESHEGO**—Samuel Sebola, P.O. Box 137, Seshogo 0742, Seshogo, Republic of South Africa

**REPUBLIC OF SOUTH AFRICA SOUTH, KWA ZULU**—Samuel Ndhlovu, P.O. Box 1042, Pietermaritzburg, Natal, Republic of South Africa

**REPUBLIC OF SOUTH AFRICA SOUTH, SOUTHEASTERN**—Frank Mncina, P.O. Box 199, Carolina, Tvl. 1185, Republic of South Africa

**REPUBLIC OF SOUTH AFRICA SOUTH, WESTERN**—Alfred Selepe, 6563 Orlando East, Soweto 1804, Tvl., Republic of South Africa

**SWAZILAND NORTH**—Leonard Sibandze, P.O. Box 832, Manzini, Swaziland, Africa

**SWAZILAND SOUTH**—Samuel Dlamini, P.O. Box 395, Mbabane, Swaziland, Africa

**TRANS SOUTH AFRICA EASTERN CAPE**—Peter Wagner, P.O. Box 8109, Schauderville 6060, Republic of South Africa

**TRANS SOUTH AFRICA NATAL**—Norman Zurcher, P.O. Box 17031, Congella 4013, Republic of South Africa

**TRANS SOUTH AFRICA NORTHERN**—George Taylor, 128 Ashburton St., Johannesburg 2093, Republic of South Africa

**TRANS SOUTH AFRICA WESTERN CAPE**—L. B. Smith, P.O. Box 74, Athlone, Cape Province 7764, Republic of South Africa

**ZAMBIA SOUTH**—Nicholas Chirwa, Box 8137 Woodlands, Lusaka, Zambia

**ZIMBABWE**—Ignatius Chavunduka, St. 154 Southerton, Salisbury, Zimbabwe

## ASIAN REGION

**INDIA EASTERN MAHARASHTRA**—D. M. Kharat, Buldana, Buldana District, Maharashtra, India

**INDIA WESTERN MAHARASHTRA**—M. V. Ingle, 4 Divya Nagar, Wandvadi, Poona-1, India

**JAPAN**—Shin Kitagawa, 51 Kasumigaoka Nishi-Ka Yokahama 220, Japan

**\*\*KOREA CENTRAL**—Cho Moon Kyung, Hap Jung Dong 364-27, Mapo Ku, Seoul 121, Korea

**\*\*KOREA EASTERN**—Park Kee Suh, Hap Jung Dong 364-27, Mapo Ku, Seoul 121, Korea

**\*\*KOREA HONAM**—Suh Jeung-Moon, Ham Yui Li Ham Ramyun, Ik San Goon Chun Pook Do, Korea

**\*\*KOREA SOUTH**—Oh Jung Hwan, 81-20 Su-kyo Dong, Jung-Ku, Taejon City, Korea 300

**PHILIPPINES EASTERN VISAYAN**—Honorio C. Mateo, Sr., 513 New Frontier Street, Mabalulo, 6401, Cebu City, Republic of the Philippines

**PHILIPPINES LUZON**—Meliton Bernabe, 7 Dewey Street, Binalonan, Panagasinan 0714, Republic of the Philippines

**PHILIPPINES METRO MANILA**—Andres Valenzuela, Greenhills P.O. Box 641, Metro Manila 3113, Republic of the Philippines

**PHILIPPINES, WESTERN VISAYAN**—Jose



Shown (l. to r.) are John Nielson, editorial director of Adult Ministries; Isaac Abundis, artist for Spanish materials; and Jose Pacheco, editorial director for Spanish periodicals.

De izquierda a derecha: John Nielson, Director Editorial de Ministerios entre los Adultos; Isaac Abundis, encargado de arte y formato de materiales en español; y José Pacheco, Director Editorial de Publicaciones Periódicas en español.





Rev. G. R. Hayse (l.), mission director of R.S.A. North field, presents an award to Mr. B. T. Mashamba, a layman on the Venda Pioneer District. The plaque reads:

**Mr. B. T. Mashamba**  
Layman of the Year, 1981  
Venda District  
Church of the Nazarene

Mr. Mashamba is the senior health officer of the Republic of Venda. This award was presented for his outstanding work on the district, and for his faithfulness in the local church. He is a member of the District Advisory Board and is the district treasurer.

Causing, P.O. Box 448, Iloilo City 5901, Republic of the Philippines

**REPUBLIC OF CHINA/TAIWAN**—Lin Ching Tung, Min Tzu West Road, Lane 205 No. 7, Taipei, Tawan 103, Republic of China

#### CANADA

**CANADA ATLANTIC**—William F. Bahan, 14 Hollywood Dr., Moncton, New Brunswick, Canada E1E 2R5

**CANADA CENTRAL**—Lorne V. MacMillan, 38 Riverhead Dr., Rexdale, Ontario, Canada M9W 4G6

**CANADA PACIFIC**—Daniel J. Derksen, 5443 Meadedale Dr., Burnaby, British Columbia, Canada V5B 2E6

**CANADA QUEBEC**—Roy Fuller, 113 Kingsley Ave., Dollard des Ormeaux, Quebec, Canada H9B 1N2

**CANADA WEST**—Alexander Ardrey, Box 3456, Station "B", Calgary, Alberta, Canada T2M 4M1

#### EUROPE AND THE MIDDLE EAST

**BRITISH ISLES NORTH**—David J. Tarrant, 149 Kenilworth Ave., Glasgow, G41 Scotland

**BRITISH ISLES SOUTH**—T. W. Schofield, 384 Walkden Road, Worsley, Manchester, M28 4QJ, England

**ITALY**—Salvatore Scognamiglio, Via A. Fogazzaro, 11, 00137 Rome, Italy

**\*JORDAN-LEBANON-SYRIA**—Jacob Ammari, P.O. Box 38, Karak, Jordan

**MIDDLE EUROPEAN**—Hugo Danker, 6 Frankfurt 50, An der Nachtweide 4, West Germany

**NETHERLANDS**—Cor Holleman, Stationes Wege 8, Barendrecht, Netherlands

**\*SCANDINAVIA**—Niels Eliassen, Fugleparken 33, 2690 Karlslunde, Denmark

#### MEXICO, CENTRAL AMERICA, AND CARIBBEAN

**BARBADOS**—Clyde Greenidge, P.O. Box 253, Bridgetown, Barbados

**\*BELIZE**—Onesimo Pot, P.O. Box 537, Belize City, Belize

**COSTA RICA**—Eddy Castillo, Apartado Postal No. 271, Tibas, San Jose, Costa Rica

**DOMINICAN REPUBLIC**—Marcos Hatchett, Apartado Postal 1819, Santo Domingo, Republica Dominicana

**EL SALVADOR**—Ramon Campos, Ave. A Maquilishwat 306, Col. Vista Hermosa, San Salvador, El Salvador

**GUATEMALA NORTHEAST**—Alfonso Barrientos, Apartado Postal 11, Coban, Alta Verapaz, Guatemala

**GUATEMALA SOUTHEAST**—Joel Buenafe Herrera, 3a. Calle 7-23, Zona 2, Guatemala, Guatemala

**GUATEMALA SOUTHWEST**—Eber Martinez, Apartado 288, Quezaltenango, Guatemala

**GUYANA**—Joseph Murugan, P.O. Box 170, Georgetown, Guyana

**HAITI NORTH**—Duroc Placide, Box 1323, Port-au-Prince, Haiti

**HAITI SOUTH**—Herman Andre, P.O. Box 1323, Port-au-Prince, Haiti

**JAMAICA**—Noel Williams, 131 Maxfield Ave., Kingston, 10, Jamaica

**\*\*LEEWARD ISLANDS/VIRGIN ISLANDS**—Dhanraj Mahabir, P.O. Box 741, Christiansted, St. Croix, Virgin Islands 00820

**\*MEXICO CENTRAL**—Moises Garces, Apartado 27-199, Mexico 7, D. F. Mexico

**\*MEXICO EAST**—Antonio Alvarado, Apartado Postal 653, Merida, Yucatan, Mexico

**\*MEXICO NORTH**—Aaron Catalan, Apartado Postal 202, Chihuahua, Chih., Mexico

**\*MEXICO NORTHEAST**—Moises Esperilla, Apartado Postal 1699, Monterrey, Nuevo Leon, Mexico

**\*MEXICO NORTHWEST**—Carlos Perea, Apartado Postal 1476, Tijuana, Baja California, Mexico

**\*MEXICO SOUTH**—Luis Aguilar, Apartado 82, Tuxtla Gutierrez, Chiapas, Mexico

**\*MEXICO WEST**—Jonas Aquino, Apartado 1-1969, Guadalajara, Jalisco, Mexico

**NICARAGUA PACIFIC**—Faustino Zepeda, Apartado 5396, Managua, Nicaragua

**PANAMA**—Jose Benicio Gordon, Apartado Postal 8378, Panama 7, Panama

**\*\*PUERTO RICO**—Benjamin Roman, RFD 3, Box 41W, Rio Piedras, PR 00924

**TRINIDAD-TOBAGO**—Farrell Chapman, P.O. Box 444, Port of Spain, Trinidad

**WINDWARD ISLANDS**—Zephaniah Mahadeo, Cane Hill Church of the Nazarene, Box 478, Kingston, St. Vincent

#### SOUTH AMERICA

**ARGENTINA CENTRAL**—Florentino Bauza, Terrero 950, 1406 Cap. Fed., Buenos Aires, Argentina

**ARGENTINA SOUTH**—Carlos Zoroastro, Las Heras 350, 8000 Bahia Blanca, Buenos Aires, Argentina

**BOLIVIA LA PAZ**—Claudio Ticona, Casilla 1056, La Paz, Bolivia

**BRAZIL SOUTHEAST**—Joaquim Lima, Caixa Postal 1008, Campinas, Sao Paulo, Brazil, 13.100

**\*PERU NORTH**—Modesto Rivera, Apartado 209, Chiclayo, Peru

**\*PERU SAN MARTIN**—Alberto Zamora, Alonso de Alvarado 1032, Mayobamba, Peru

**\*PERU SOUTH**—Ernesto Lozano, Chaquiras 182 Ate—Salamanca, Lima, Peru

**URUGUAY**—John Sluyter, Juan Manuel Perez 5942, Montevideo, Uruguay

#### SOUTH PACIFIC

**AUSTRALIA NORTHERN PACIFIC**—John White, 15 Bettina St., MacGregor, Queensland 4109, Australia

**AUSTRALIA SOUTHERN**—Jay E. Hunton, P.O. Box 211, Glen Waverly 3150, Melbourne, Victoria, Australia

**NEW ZEALAND**—Dwight Neuenschwander, 30 Riverhills Ave., Pakuranga, Auckland, New Zealand

**PAPUA NEW GUINEA HIGHLANDS**—Taima Dirye, c/o Lee Eby, Box 416, Mount Hagen, WHP, Papua New Guinea

#### UNITED STATES

**CENTRAL U.S.A.**

**CHICAGO CENTRAL**—Forrest W. Nash, 239 E. Anderson St., Bourbonnais, IL 60914

**EASTERN MICHIGAN**—Donald J. Gibson, 6477 N. Burkhardt Rd., Howell, MI 48843

**ILLINOIS**—John J. Hancock, 715 W. Prospect, Springfield, IL 62704

**INDIANAPOLIS**—John F. Hay, P.O. Box 46, Camby, IN 46113

**MICHIGAN**—C. Neil Strait, 2754 Barfield Dr. S.E., Grand Rapids, MI 49506

**NORTHEASTERN INDIANA**—Bruce T. Taylor, 2122 Valley Ave., Marion, IN 46952

**NORTHWEST INDIANA**—Thomas M. Hermon, P.O. Box 350, Valparaiso, IN 46383

**NORTHWESTERN ILLINOIS**—Floyd H. Pounds, 5908 Trenton Ln., Peoria, IL 61614

**SOUTHWEST INDIANA**—B. G. Wiggs, 228 Westwood Dr., Bedford, IN 47421

**WISCONSIN**—J. Ted Holstein, 2807 Waunona Way, Madison, WI 53713

#### EAST CENTRAL U.S.A.

**AKRON**—Floyd O. Flemming, 7810 Lakefield St. N.E., Louisville, OH 44641

**CENTRAL OHIO**—J. Wilmer Lambert, 2708 Morse Rd., Columbus, OH 43229

**EASTERN KENTUCKY**—John W. May, Box 791, Mount Sterling, KY 40353

**NORTH CENTRAL OHIO**—D. E. Clay, P.O. Box 947, Mount Vernon, OH 43050

**NORTHWESTERN OHIO**—M. V. Scutt, Box 286, St. Marys, OH 45885

**SOUTHWESTERN OHIO**—Harold B. Graves, 1716 N. Breiel Blvd., Middletown, OH 45042

**WEST VIRGINIA**—M. E. Clay, 5300 MacCorkle Ave. S.E. (P.O. Box 4357), Charleston, WV 25304



## Your Opportunity for EXTRA INCOME

**Christmas Cards • Stationery  
Towel Calendars • Gift Wrap  
Selected Gifts**

Yes, I am interested in selling Christian-related items. Please RUSH information on the **1981 Christmas Agent's Plan.**

Name \_\_\_\_\_  
Street \_\_\_\_\_  
City \_\_\_\_\_  
State/Province \_\_\_\_\_

MAIL TO: ZIP \_\_\_\_\_

Agent's Division  
**NAZARENE PUBLISHING HOUSE**

Post Office Box 527, Kansas City, Missouri 64141

HH81

**EASTERN U.S.A.**

**EASTERN LATIN AMERICA**—Jose Cardona,

16-09 George St., Fair Lawn, NJ 07410

**MAINE**—J. E. Shankel, 1040 Riverside Dr., Augusta, ME 04330

**NEW ENGLAND**—William A. Taylor, 180 Adams St., Quincy, MA 02169

**NEW YORK**—Dallas Mucci, Box 179, Yorktown Heights, NY 10598

**PHILADELPHIA**—Paul D. Mangum, 119 Talleyrand Rd., P.O. Box 513, West Chester, PA 19380

**PITTSBURGH**—Jerry D. Lambert, 175 North Rd., Butler, PA 16001

**UPSTATE NEW YORK**—George E. Teague, 400 Longmeadow Dr., Syracuse, NY 13205

**VIRGINIA**—Reeford L. Chaney, 3910 Monza Dr., Richmond, VA 23234

**WASHINGTON**—Roy E. Carnahan, 2509 Jonathan Rd., Ellicott City, MD 21043

**NORTH CENTRAL U.S.A.**

**DAKOTA**—F. Thomas Bailey, Box 1100, Jamestown, ND 58401

**IOWA**—Forrest E. Whitlatch, P.O. Box 1067, Oskaloosa, IA 52577

**JOPLIN**—James C. Hester, P.O. Box 551, Carthage, MO 64836

**KANSAS**—C. Marselle Knight, 1833 W. 13th, Wichita, KS 67203

**KANSAS CITY**—Milton B. Parrish, P.O. Box 4404, Overland Park, KS 66204

**MINNESOTA**—Virgil K. Grover, 6224 Concord Ave. S., Minneapolis, MN 55424

**MISSOURI**—Arthur E. Mottram, 4557 Harvshire Ct., St. Louis, MO 63128

**NEBRASKA**—James Diehl, Box 925, Hastings, NE 68901

**NORTHWEST U.S.A.**

**ALASKA**—Robert W. Sheppard, 3200 Princeton Way, Anchorage, AK 99504

**COLORADO**—M. Harold Daniels, Box 470, Littleton, CO 80120

**INTERMOUNTAIN**—Hoyle C. Thomas, P.O. Box 1159, Nampa, ID 83651

**NORTHWEST**—Walter E. Lanman, 14510 N. Gleneden Dr., Spokane, WA 99208

**OREGON PACIFIC**—Carl B. Clendenen, Jr., P.O. Box 1088, Salem, OR 97308

**ROCKY MOUNTAIN**—Darrel L. Slack, 1112 Parkhill Dr., Billings, MT 59102

**WASHINGTON PACIFIC**—Kenneth Vogt, 2500 Talbot Crest Dr., Renton, WA 98055

**SOUTH CENTRAL U.S.A.**

**CENTRAL LATIN AMERICA**—H. O. Espinoza, Box LH094, San Antonio, TX 78212

**DALLAS**—W. M. Lynch, 2008 Tulane, Richardson, TX 75081

**HOUSTON**—D. W. Thaxton, 1000 FM 1960W, Suite 203, Houston, TX 77090

**LOUISIANA**—Ralph E. West, 1248 Southampton Dr., Alexandria, LA 71301

**NORTH ARKANSAS**—Thomas M. Cox, P.O. Box 1468, Conway, AR 72032

**NORTHEAST OKLAHOMA**—W. T. Dougharty, 5916 E. 47th Pl., Tulsa, OK 74135

**NORTHWEST OKLAHOMA**—Bill E. Burch, P.O. Box 887, Bethany, OK 73008

**SAN ANTONIO**—James R. Blankenship, 200 Gardenview Dr., San Antonio, TX 78213

**SOUTH ARKANSAS**—Donald Irwin, 2824 Charter Oak Rd., Little Rock, AR 72207

**SOUTHEAST OKLAHOMA**—Wendell O. Paris, Box 699, Henryetta, OK 74437

**SOUTHWEST OKLAHOMA**—M. Bert Daniels, Box 75412, Oklahoma City, OK 73147

**WEST TEXAS**—Gene Fuller, Box 6650, Lubbock, TX 79413

**SOUTHEAST U.S.A.**

**ALABAMA**—W. Charles Oliver, P.O. Box 419, Pelham, AL 35124

**CENTRAL FLORIDA**—J. V. Morsch, 10900 Turkey Lake Rd., Orlando, FL 32809

**EAST TENNESSEE**—Doyle C. Smith, P.O. Box 8097, Chattanooga, TN 37411

**GEORGIA**—Jack H. Lee, 3612 Calumet Rd., Decatur, GA 30034



Pictured at the Central Ohio District assembly (l. to r.) are Dr. Charles H. Strickland, general superintendent; ordinands and wives, Rev. and Mrs. James Lattimer, Rev. and Mrs. Curtis Sellers, Rev. and Mrs. Edward W. Morrison, Rev. and Mrs. Douglas C. Ringhiser, Rev. and Mrs. Ralph E. Skillings, Rev. and Mrs. Robert S. Snyder, Rev. and Mrs. James A. Miller, Rev. and Mrs. Marvin W. Bunde, Rev. and Mrs. Aaron R. Abney, and Dr. J. Wilmer Lambert, district superintendent.



Pictured at the Illinois District assembly (l. to r.) are Dr. Orville W. Jenkins, general superintendent, with ordinands and their wives, Rev. and Mrs. Larry L. Leonard, Rev. and Mrs. William H. Burton, Rev. and Mrs. Edward G. Stovall, Rev. and Mrs. Elmer B. Ferguson; and Dr. James E. Hunton, retiring district superintendent.



Pictured (l. to r.) at the Northwest Oklahoma District assembly are: Dr. Bill E. Burch, district superintendent; ordinands Robert H. Maine, Keith A. Maule, Danny R. McMahan, Kenneth A. Skipworth, Felix Vigil, Gary Bergman, Dr. James Garlow (credentials recognized); and Dr. Jerald D. Johnson, general superintendent.



Pictured (l. to r.) with Dr. M. E. Clay, superintendent of the West Virginia District, are ordinands John D. Prichard, William E. Carte, Arnett L. Hughes, Kenneth "Bob" Herdman, John T. Hayes, Donnell Armstrong, Allen Shortridge, and Jerry L. Sudduth. They were ordained by General Superintendent V. H. Lewis during the district assembly.

**KENTUCKY**—Aleck G. Ulmet, P.O. Box 32093, Louisville, KY 40232

**MISSISSIPPI**—J. W. (Bill) Lancaster, P.O. Box 8426, Jackson, MS 39204

**NORTH CAROLINA**—Oval Stone, 7609 Linda Lake Dr., Charlotte, NC 28215

**NORTH FLORIDA**—Jonathan T. Gassett, 4608 N.W. 41st St., Gainesville, FL 32601

**SOUTH CAROLINA**—D. Moody Gunter, 181 E. Selwood Ln., Columbia, SC 29210

**SOUTHERN FLORIDA**—Robert H. Spear, Jr., P.O. Box "N," Boca Raton, FL 33432

**TENNESSEE**—W. Talmadge Johnson, 1941 Otter Creek Rd., P.O. Box 15941, Nashville, TN 37215

#### **SOUTHWEST U.S.A.**

**ARIZONA**—Crawford Vanderpool, Suite 212, 3001 W. Indian School Rd., Phoenix, AZ 85017

**CENTRAL CALIFORNIA**—Wil M. Spaite, 1535 E. Indianapolis, Fresno, CA 93704

**HAWAII PACIFIC**—Darrell Teare, P.O. Box 6254, Honolulu, HI 96818

**LOS ANGELES**—Paul W. Benefiel, 1546 E. Washington Blvd., Pasadena, CA 91104

**NEW MEXICO**—Leon F. Wyss, P.O. Box 11627, Albuquerque, NM 87192

**NORTH AMERICAN INDIAN**—Julian Gunn, 4229 N. 16th Dr., Phoenix, AZ 85015

**NORTHERN CALIFORNIA**—Grady W. Cantrell, 3000 Citrus Cir., Suite 103, Walnut Creek, CA 94598

**SACRAMENTO**—Walter M. Hubbard, P.O. Box 160382 Sacramento, CA 95816

**SOUTHERN CALIFORNIA**—Robert Scott, 524 E. Chapman Ave., Orange, CA 92666

**WESTERN LATIN AMERICA**—Juan Madrid, 1570 N. Holliston Ave., Pasadena, CA 91104

**\*IMPORTANT**—Correspond using plain envelope. It is hazardous to the receiver if "Rev." or church name appears in either the address or the return address.

\*\*Do not use air forms when corresponding.

**NOTE**—Mail to Germany—It needs to be labeled "East" or "West" or it won't be accepted.

Mail to Italy—Stamp **FOREIGN MAIL** in addition to putting **ITALIA** in capital letters. Emergency communication must be by telegram.

## **DISTRICT ASSEMBLY REPORTS**

### **CENTRAL OHIO**

The 38th annual assembly of the Central Ohio District met at Columbus, Ohio. District Superintendent J. Wilmer Lambert, serving under appointment, was elected for a one-year term and reported two new churches organized: Newark Central and New Albany Trinity.

Presiding General Superintendent Charles H. Strickland ordained Aaron R. Abney, Marvin W. Bunde, James A. Miller, Edward W. Morrison, Douglas Charles Ringhiser, Barry Curtis Sellers, and Robert Sheldon Snyder, and recognized the credentials of James Lattimer and Ralph E. Skillings.

Elected to the Advisory Board were elders Kenneth D. Ellis, William G. Hill, Bobby G. Madison, and Robert F. Styers, and laymen James C. Cline, Paul W. Gamertsfelder, Jack C. Hansher, and Homer R. McKnight.

Mrs. J. Wilmer Lambert was elected NWMS president; Rev. C. William Parsons was reelected NYI president; and Rev. Bobby G. Madison was elected chairman of the Board of Christian Life.

### **VIRGINIA**

The 40th annual assembly of the Virginia District met in Buckingham, Va. District Superintendent Reeford L. Chaney, completing the third year of an extended term, reported four new churches organized: Gloucester, Martinsville Rich Acres, Richmond Mount Zion, and Salem.

Dr. William M. Greathouse, presiding general

superintendent, ordained Louis Michael Lamphire and Gary Felix Smith.

Elders Robert E. Field, A. H. Johnson, and C. L. Thompson; and laymen Raymond Carr, Leroy Cox and Harry Tribby, Jr., were elected to the Advisory Board.

Mrs. Reeford Chaney was reelected NWMS president. Timothy Taylor was elected NYI president, and Jim Paul Stewart was reelected chairman of the Board of Christian Life.

### **DALLAS**

The 73rd annual assembly of the Dallas District met at Texarkana, Tex. District Superintendent W. M. Lynch, completing the first year of an extended term, reported three new churches organized: Cedar Hill, Dallas Calvary, and Dallas Primera Iglesia.

Presiding General Superintendent Eugene L. Stowe ordained Thomas Eugene Eaton, William Richard Knox, Jr., and Patrick McCown.

Elected to the Advisory Board were elders J. Lewis Ingle, Leon Martin, and Jesse C. Middendorf, and laymen David McClung, Ralph Randall and Arless Wilson.

Mrs. W. M. Lynch was reelected NWMS president; David Roland was reelected NYI president; and Jesse C. Middendorf was reelected chairman of the Board of Christian Life.

### **ILLINOIS**

The 38th annual assembly of the Illinois District met at Springfield, Ill. Retiring District Superintendent James E. Hunton reported, and Rev. John Hancock was elected district superintendent for a one-year term.

General Superintendent Orville W. Jenkins ordained Larry L. Leonard, William H. Burton, Edward G. Stavall, and Elmer B. Ferguson.

Elected to the Advisory Board were elders

Cecil H. Carroll, Sr., Gilbert Hughes, and John Ruzich and laymen Kent Nisbet, Gerald Oliver, and Kenneth Whittington.

Reelected to their respective positions were Lorene Whittington, NWMS president; William D. Chenault, NYI president; and L. W. Hindmand, chairman of the Board of Christian Life.

### **NORTHWEST OKLAHOMA**

The 33rd annual assembly of the Northwest Oklahoma District met in Bethany, Okla. District Superintendent Bill E. Burch, completing the second year of an extended term, reported.

Dr. Jerald D. Johnson, general superintendent, ordained Gary Lee Bergman, Robert Henry Maine, Danny Ray McMahan, Keith Allen Maule, Kenneth Albert Skipworth, Felix D. J. Vigil, and recognized the credentials of James Lester Garlow.

Elders Ponder W. Gilliland, Gary F. Powell, and Loy Watson were elected to the Advisory Board. Laymen elected to the Board were Gene Post, J. Dudley Powers, and Don Schuneman.

Drs. Stephen Gunter was reelected NWMS president; Rev. James Russon was reelected NYI president; and A. B. "Bud" LeCrone was reelected chairman of the Board of Christian Life.

### **WEST VIRGINIA**

The 42nd annual assembly of the West Virginia District convened at Summersville, W.Va. District Superintendent M. E. Clay, completing the second year of an extended term, reported.

Presiding General Superintendent V. H. Lewis ordained Donnell Armstrong, William E. Carte, John Thomas Hayes, Kenneth Allen Herdman, Arnett L. Hughes, John David Prichard, Rockford Allen Shortridge, and Jerry L. Sudduth.



## **Help us keep your periodicals coming by:**

# 1

Sending label from *EACH* publication showing old address

**PLEASE ATTACH LABEL  
FROM MOST RECENT ISSUE**

# 2

Giving us your *NEW* address in space provided below

Date \_\_\_\_\_

Name \_\_\_\_\_

Street \_\_\_\_\_

City \_\_\_\_\_

State/Province \_\_\_\_\_ Zip \_\_\_\_\_

**NOTE:** Allow up to six weeks for processing address change.

Mail to: **SUBSCRIPTION DEPARTMENT  
NAZARENE PUBLISHING HOUSE**  
Post Office Box 527, Kansas City, Missouri 64141

Elected to the Advisory Board were elders Robert L. Green, B. W. Hambrick, Leroy K. Hostutler, Kenneth Maze, and C. Harold Smith and laymen Russell "Mack" Bailey, Donald L. Estep, Jan R. Forman, Orville Jones, and Dallas Moore

NWMS president Mrs. M. E. Clay, NYI president Rev. Terry Solina, and chairman of the Board of Christian Life Mr. Jan R. Forman, were all reelected to their respective positions.

#### TENNESSEE

The 70th annual assembly of the Tennessee District met in Nashville. District Superintendent W. Talmadge Johnson was reelected for a four-year term.

Presiding General Superintendent Orville W. Jenkins ordained Paul Belcher, Gary Jakes, Jack Barnes and recognized the credentials of William Dever.

Elders Millard Reed, James Craig, Harold Latham, and Robert Mitchell, and laymen Wendell Poole, Levi Barnes, Leon Guill, and Ed Whittington were elected to the Advisory Board.

Mrs. Genell Johnson was elected NWMS president; Rev. Steve Green was elected NYI president; and Rev. Jay Bybee was elected chairman of the Board of Christian Life.

#### CORRECTION

In the report of the Houston District assembly (September 1 issue), the name of the NYI president was mistakenly listed as Kelly Mills. It should have read Kerry Mills. We apologize for repeating the error in copy sent us from the district.

#### MOVING MINISTERS

MILTON A. AKEY to Council Bluffs (Ia.) Emanuel  
KENNETH M. BILCORN from Worcester, Mass., to Elmsdale, Prince Edward Island, Canada  
GLENN AMERSON from Blue Island, Ill., to Ottumwa (Ia.) Trinity  
JIMMY R. ARMSTRONG from Camden, Ark., to Wister, Okla.  
WILLIAM D. ARNDT to Stephenville, Tex.  
HOWARD N. BECKER from Cincinnati (Ohio) Fairfax to Bethel, Ohio  
WESLEY J. BICHSEL from student, Nazarene Theological Seminary, Kansas City, to Veneta, Ore.  
LAWRENCE O. BLIGHT from associate, Eugene (Ore.) First, to associate, Puyallup, Wash.  
THOMAS BOCOX from Cleveland (Miss.) Davis Chapel to Houston, Miss.  
FRED BORGER, JR. from Council Bluffs (Ia.) Emanuel to Burlington (Ia.) Flint Hills  
A. MICHAEL BROWN from Montpelier, Ohio, to Lowell, Ind.  
MARK A. BROWN from Ridgeville, Ind., to Kokomo (Ind.) Forest Lawn  
DANNY K. BRUMMETT from Frankfort (Ky.) Capitol to Bicknell, Ind.  
VICTOR M. BUFFEY from Yazoo City, Miss., to Sledge (Miss.) Robinson Chapel  
VIRGIL BYRER from Watkins Glen, N.Y., to Pomeroy, Ohio  
PAUL T. BYRNS from Mackey, Ind., to Cayuga, Ind.  
LARRY D. CLASSEN from associate, Sacramento (Calif.) Liberty Towers to Gilroy, Calif.  
CLEO D. ELSBERRY to White Mountain, Ariz.  
GARY E. FARRIS, SR., from Glasgow (Ky.) Trinity to Lenoir City (Tenn.) White Wing  
BRANDT F. FREEBURG from Sioux City (Ia.) Central to Bloomfield, Ia.  
J. B. FUSTIN from Evansville (Ind.) Diamond Valley to Martinsville (Ind.) Trinity  
DONALD C. GADBOW from Iowa City, Ia., to Newton, Ia.  
RAY L. GIBSON from Lexington (Ky.) Calvary to Paducah, Ky.  
BRADLEY J. GILBERT to Needmore, Pa.  
HAROLD B. GRAVES, JR., from Charlotte (N.C.) Plaza to Amarillo (Tex.) First

W. GENE HANSEN from Buhl, Ida., to Caldwell (Ida.) First  
DALE D. HARDY from Yarmouth, Me., to associate, New Philadelphia, Ohio  
JAMES S. HAYNE to Boulder (Colo.) First  
ROBERT HIGHLEY from South Lebanon, Ohio, to Cincinnati (Ohio) Fairfax  
DAVID C. HOLSTEIN to Columbus (Ohio) Whitehall  
KENNETH D. HULL to Bard, Calif.  
CECIL A. JONES from Waldoboro, Me., to Pataskala, Ohio  
BEN B. KAECHLE from Shelburne, Ontario, Canada, to Windsor, Nova Scotia, Canada  
TERRY A. KIDD from Batavia (Ohio) Community to Hamilton (Ohio) First  
FRANK G. KISH from Topeka (Kans.) Lakeview to associate, Roanoke (Va.) First  
CLIFFORD H. LAWHORN from Erlanger, Ky., to South Lebanon, Ohio  
WALTER T. MAHANY from Merrifield, Minn., to Chestertown, Md.  
ROBERT H. MAINE to Crescent, Okla.  
STUART A. MALLOY from associate, Lubbock (Tex.) First, to Waco (Tex.) South Manor  
CHARLES MARTIN from Smithville, Tenn., to Crossville, Tenn.  
JIM K. MEANS from Clarinda, Ia., to Indianola, Ia.  
RICHARD S. MILLER to Tucson (Ariz.) Northside  
BRUCE MODESITT from Crossville, Tenn., to Sweetwater (Tenn.) First  
LEHMAN R. MOSELEY from associate, Stockton (Calif.) First, to associate, Columbus (Ohio) First  
RONALD D. MOSS from Bridgeton, N.J., to Reading (Pa.) Calvary  
MARLIN A. MOYER from Kokomo (Ind.) Forest Lawn to Loveland, Ohio  
ALVIN J. OWENS from Calhoun City, Miss., to New Albany, Miss.  
WILLIAM L. PARKS from Girard, Ohio, to Lake Havasu City, Ariz.  
CHARLES G. PARSONS to Patricksburg, Ind.  
MARY LOU RUTGERS from Holland, Mich., to Stevens Point, Mich.  
DAVID L. SCHOOLER from Branson, Mo., to Lebanon, Ohio  
JAMES SLAUGHTER from Dayton (Ohio) Pleasant Valley to Centerville, Ohio  
BRYAN E. SOLOMON from Paducah, Ky., to Indianapolis (Ind.) Fall Creek  
GENE C. TANNER from associate, Elkhart (Ind.) First, to Oxford, Ohio  
DALE K. TWYEFFORT from Eliot, Me., to Waldoboro, Me.  
SCOTT K. VAN BIBBER to Prescott, Ariz.  
DARRYLE L. VAUGHT from Springfield, Tenn., to Selmer, Tenn.  
DICK W. WALDEN from Burlington (Ia.) Flint Hills to Creston, Ia.  
RICK L. WILLIAMSON from Ottumwa (Ia.) Trinity to Iowa City, Ia.  
EUGENE H. WISEMAN from Albany (Ga.) First to Warner Robins, Ga.

#### MOVING MISSIONARIES

JOHN ADAMS, Papua New Guinea, Furlough address: 616 Diamond, Nampa, ID 83651  
DOROTHY AHLEMAN, Argentina, Furlough Address: 118 S. Main St., Oakland City, IN 47660  
EDWIN BROADWAY, Papua New Guinea, Furlough address: 10430 Lippincott Rd., Davison, MI 48423  
PETER BURKHART, Philippines, Field address: P.O. Box 116, Legaspi City, Albay, Republic of Philippines  
LOUIE BUSTLE, Dominican Republic, Furlough address: 1605 Willow Dr., Olathe, KS 66062  
LOIS DRAKE, Swaziland, Furlough address: 701 Airfield Ln., Midland, MI 48640  
EMMA LOU FETTERS, Swaziland, Furlough address: c/o Don Scarlett, P.O. Box 1196, Gainesville, FL 32602  
CHARLES GAILEY, Swaziland, Furlough address: 1917 Jamestown, Dr., Olathe, KS 66062  
CHARLES GATES, Brazil, Furlough address: 1594 N. Allen, Apt. 14, Pasadena, CA 91104

NEW!



THANKSGIVING  
Program Builder No. 2

Plan something a little different and special during this Thanksgiving season. Here **EVERLYN STENBOCK** has compiled songs, skits, recitations, and readings that can be used in a variety of ways and places, reminding people of their many blessings. 32 pages. Paper. **MP-404** **\$1.50**

OTHER EDITIONS

compiled by Grace Ramquist  
No duplication of materials

<b>MP-403</b> Thanksgiving Program Builder No. 1	<b>\$1.50</b>
<b>MP-401</b> Our Gratitude	<b>\$1.50</b>

NOTE: You will need at least three (3) copies of a title: one for the director, and two to clip.  
*Prices subject to change without notice*

Order NOW!

NAZARENE PUBLISHING HOUSE  
Post Office Box 527, Kansas City, Missouri 64141

STEPHEN HEAP, Brazil, Field address: Rua do Pinal 227, Boa Viagem, 50 000 Recife, P. E., Brazil  
FRED HUFF,\* New Zealand, Furlough address: 3612 Calumet Rd., Decatur, GA 30034  
TERRY KETCHUM, France, Field address: A.F.E.B. Centre Missionnaire, 50, Rue des Galbouds, F. 73200, Albertville, France  
WANDA KNOX, Israel, Furlough address: Bethany First Church, 6789 N.W. 39th Expressway, Bethany, OK 73008  
RUSSELL LOVETT, Italy, Furlough address: 1704 Jackson Ave., Portsmouth, OH 45662  
AVINELL McNABB, Swaziland, Furlough address: Box 160, Rte. 3, Greenbrier, AR 72058  
DON MESSER, Malawi, Field address: P.O. Box 302, Lilongwe, Malawi  
DR. DON OWENS, Asia South Pacific Regional Director, Field address: P.O. Box 179, Greenhills, Rizal, 3113 Metro Manila, Republic of Philippines  
MARY PEACOCK, Swaziland, Field address: P.O. Box 14, Manzini, Swaziland  
LENORA PEASE, India, Furlough address: 943 38th St. S.W., Calgary, Alberta, Canada, T3C 1T4  
ROBERT PERRY, Swaziland, Field address: Box 121, Siteki, Swaziland  
TERRY READ, Haiti, Furlough address: 1601 Kensington, Westchester, IL 60153  
CARL ROMÉY, Brazil, Field address: c/o Mr. Paul Phillips, Caixa Postal 10-2385, 70 000 Brasília, D.F., Brazil  
DAVID W. TAYLOR,\* Haiti, Field address: B.P. 1323, Port-au-Prince, Haiti  
JANET WATSON, Papua New Guinea, Furlough address: 709 S. Mahaffie, Olathe, KS 66061  
PRESCOTT BEALS, India, Retired, Stateside

address: Camlu Apts., No. 13, 1701 Plaza Way, Walla Walla, WA 99362

REGINALD JONES, Republic of South Africa. Retired. Pastoral address: P.O. Box 368, Pietermaritzburg 3200, Republic of South Africa

CATHERINE ECKEL MORRIS, Japan, Retired. Stateside address: 1009 Dara, Camarilla, CA 93010

\*Specialized Assignment Personnel

## ANNOUNCEMENTS

**Muskogee, Okla., First Church** will celebrate its 60th anniversary with special services October 14-18. Dr. V. H. Lewis will be the special speaker. Former pastors and friends are invited to share a Special Day of Celebration on Sunday, October 18. F. H. Bolerjack is the pastor. For more information, call 918-682-2592.

**Parkersburg, W.Va., First Church** will celebrate its 50th anniversary October 20-25. Former members and friends are invited to attend. Former pastors will be speaking each night. For further information, call 304-422-2844 or 304-863-5477.

The **Kellogg, Ida., church** will celebrate its 40th anniversary October 25. All former pastors and members are invited to attend. Call 208-784-6951 or 208-682-2238.

The **Coeur d'Alene, Ida., church** will celebrate its 40th anniversary the month of October, with the 25th the anniversary Sunday. Every Sunday will have special features with the climax on the 25th when District Superintendent Walter E. Lanman will bring the message. All past members, pastors, and friends are invited to join in this celebration. Call 208-664-5854 or 208-664-8675 for further information.

Pastor Terry Rohlmeier and the congregation of **Springdale, Ark. First Church**, 415 W. Emma, Springdale, AR 72764, invite all former pastors, members, and friends to attend the 50th anniversary celebration Sunday, October 25, at 9:45 a.m. and 5 p.m. For further information, call 501-751-9108.

October 25, members and friends of **Olathe, Kans., College Church** will celebrate the 50th anniversary of the organization of the church, and will dedicate the new 4,000 seat sanctuary and education unit. All members, former members, former pastors, and friends are invited to attend the morning service. Dr. Charles H. Strickland, general superintendent, will be speaking. For further information, contact Dr. Paul Cunningham, 913-765-4575.

The **Arcadia, Fla., church** will observe its 50th anniversary Sunday, October 25. Former pastor, W. E. McCumber, will be the special speaker. All former members, pastors, and friends are invited. For more information, call 813-494-1861.

The **Cuba, Ill., church** will celebrate its 40th anniversary November 6-8. Featured will be a history service, dinner on the grounds, and a mortgage-burning service. Dr. Jerald D. Johnson, general superintendent, and Dr. Floyd Pounds, district superintendent, will be the special speakers. All former pastors, members, and friends are invited to attend. For more information, write Mrs. Lela Barrick, P.O. Box 113, Rte. 2, Cuba, IL 61426 or call (309) 785-5101.

Observing its 35th anniversary, **Victoria, B.C., First Church** is planning a special homecoming and 35th anniversary celebration January 2-3. Former pastors and members are invited. Contact Rev. Roland H. Feltmate at 4277 Quadra Street, Victoria, B.C. V8X 1L5. Speaker at the banquet January 2 will be Rev. William F. Bahan. Dr. Edward Lawlor will speak at both services on Sunday the 3rd.

## RECOMMENDATIONS

I am happy to recommend REV. HOWARD CASTEEL, who is returning to full-time evangelism. He has six years experience as a successful pastor and preaches messages of

evangelism with a pastor's heart. Rev. and Mrs. Casteel travel in a self-contained trailer. He will consider all invitations. Contact him through the Nazarene Publishing House, Box 527, Kansas City, MO 64141, or phone him at 501-224-2901.—*Don Irwin South Arkansas district superintendent.*

CHAPLAIN KARLA OGDEN, U.S. Navy, is going into Naval Reserve status in December, 1981, and will be available in the field of evangelism. Numerous pastors, from both large and small churches, have been impressed by the effectiveness of her messages. You may contact Chaplain Karla Ogden, Station Chapel, Naval Air Station, Lemoore, CA 93245.—*Wil M. Spaitte, Central California district superintendent.*

It is a pleasure to recommend REV. S. F. HICKE as an evangelist. He has served successfully as both a pastor and an evangelist, in an effective expository holiness ministry of God's Word. I recommend him without hesitation to any congregation. He may be reached at 6655 Hubbard Ln., Tinley Park, IL 60477.—*Floyd H. Pounds, Northwestern Illinois district superintendent.*

Evangelists may be reached through the Department of Evangelism's toll-free number, 800-821-2154.

## VITAL STATISTICS

### FATHER OF PAUL SKILES PASSES AWAY

Mr. Clarence E. Skiles, 80, father of Media Services Director Paul Skiles, passed away

Sunday, Sept. 13, in Santa Ana, Calif. He died of complications resulting from a massive stroke two weeks previous.

Mr. Skiles was an active layman for many years on the Southern California District. Most recently he had been involved in SAM (Senior Adult Ministries) in the Southwest.

The funeral service was held Sept. 16 at Santa Ana First Church. Pastor Maurice Hall and Rev. Robert Scott, Southern California district superintendent, officiated.

Mr. Skiles is survived by his wife, Ruth; three sons: Albert of Santa Ana, Calif.; Paul of Overland Park, Kans.; and Richard of Turlock, Calif.; eight grandchildren and four great-grandchildren.

### LONG-TIME CHURCH SCHOOL BOOSTER DIES

Lois Potter passed to her reward August 28, 1981. She became afflicted with a brain illness, cerebral atrophy, about four and a half years ago. Her husband, Lyle, cared for her for two and a half years until she became completely helpless. She was hospitalized the last two years of her life.

The Potters represented the Department of Church Schools and the Nazarene Publishing House across the denomination for 17 years. They did this in connection with their own schedule of evangelistic, convention, and tour work. Lois provided gospel music as a soloist and organist that inspired thousands across the United States, Canada, and Alaska. Lyle did the speaking and preaching, and both held training sessions for Sunday School workers.

Lois is survived by her husband, Rev. Lyle K.



## When should you plan your will?

### (choose any 4)

- After the birth of your first grandchild.
- When one of the "old gang" expires suddenly.
- During your pastor's next sermon on heaven.
- Other \_\_\_\_\_

Any of the above may serve to remind us that time is still marching—and today is a very good time to prepare your will, so that your heirs won't be at loose ends "tomorrow."

Your church, too, can benefit—or Christian education or missions. You can put the whole world in your will through a special bequest to the work of Christ.

**HOW TO START:** Use the coupon at right to request our free booklet, "How to Write a Will That Works." There's no obligation.



Life Income Gifts Services  
Church of the Nazarene  
6401 The Paseo  
Kansas City, MO 64131  
Attn: Robert W. Crew

In Canada:  
Church of the Nazarene  
Executive Board  
Box 30080, Station B  
Calgary, Alberta, Canada  
T2M 4N7

Mr. \_\_\_\_\_  
Mrs. \_\_\_\_\_  
Miss \_\_\_\_\_  
Address \_\_\_\_\_  
City \_\_\_\_\_  
State \_\_\_\_\_ ZIP \_\_\_\_\_  
Telephone \_\_\_\_\_  
Birth Date \_\_\_\_\_ (Mon.) (Day) (Year)

Potter; one daughter, Joy Anderson; and three grandchildren.

#### DEATHS

**PERCY EUGENE BAWCOM**, 89, died June 11 in Lodi, Calif. Funeral services were conducted by Rev. Bernard P. Hertel. He is survived by his wife, Allie; 2 sons, Eugene and Jack; 3 daughters, Lorene Duke, Margaret Miller, and Ruth Bitterman; 18 grandchildren; and 31 great-grandchildren.

**CLAYTON D. BLAISDELL**, 74, died Apr. 24 in Augusta, Me. Funeral services were conducted by Rev. Larry Fairbanks. Surviving are his wife, Mary; three daughters; and two grandchildren.

**ELLA FIETH**, 95, died March 6 in Fredericktown, Mo. Funeral services were conducted by Revs. Eldon Kirks, Blanton Cook, and Ellis Lewis at the Wright City, Mo., church. Interment was in Warrenton, Mo. She is survived by one daughter, Malinda Schwartz; two sisters; and one brother.

**LESTER D. GIBBS**, 65, died June 15 in Titusville, Pa. Services were conducted in Spartansburg, Pa., by Rev. Thomas Stewart and Rev. Robert Roden. Survivors include his wife, Genevieve; two sons, Herbert W. and Lester, Jr.; seven grandchildren; four brothers; and four sisters.

**TERRY DEAN McCOY**, 22, died May 13 in Houston, Tex. Funeral services were conducted by Rev. J. Emory Lindsey and interment was in Sandersville, Ga. He is survived by his mother and father, Jeanette and Dean; and one sister, Sherrie.

**PRESTON MILLER** died June 18 in Kewanee, Ill. Funeral services were conducted by Rev. C. Huff and Rev. Lester Anderson. He is survived by his wife, Mary; his parents; and four sisters.

**ROBERT H. SENN**, 63, died June 22 in Coal Creek Canyon, Colo. Funeral services were conducted by Rev. Bill Easterling in Loveland, Colo. He is survived by his wife, Bette; 2 sons, Carroll and Jerry; 4 daughters, Alison, Jennifer, Nancy, and Brenda; 11 grandchildren; 1 brother; and 2 sisters.

**RUTH P. SPAITE**, 85, died Apr. 20 in Pasadena, Calif. Funeral services were conducted by her pastor, Rev. James H. Ingalls, and Dr. J. George Taylorson. She is survived by one son, District Superintendent Wil M. Spaitte; two daughters, Lois Hoppe and Ethel Spaitte; eight grandchildren; five great-grandchildren; and one sister.

**WILLIAM URE**, 78, died May 8 in Kingston, Mo. Funeral services were conducted by Rev. Milford Schmidt. He is survived by his wife, Clara Lee.

**MARK CLAY WALKER**, 24, died Apr. 10 from an auto accident in Shreveport, La. Funeral services were conducted by Rev. Robert A. Hayes and District Superintendent Ralph E. West. Survivors include a daughter, Jessica Ann; his parents, Ted and Evelyn; one sister; and one brother.

## "Showers of Blessing"

### PROGRAM SCHEDULE



October 25  
"Jesus Defines Greatness"

November 1  
"God's Birth Announcement"

by W. E. McCumber, speaker

# NEWS OF RELIGION

**RELIGIOUS KNOWLEDGE AT LOW LEVEL.** The Princeton Religious Research Council reports a sorry state of biblical knowledge in the United States and a shocking lack of knowledge about the basis of the nation's Judeo-Christian heritage. The trend threatens to undermine organized religion in the 1980s.

A recent Gallup Youth Survey shows that only 3 teens in 10—most of whom stated their religious preference as Christians—are correctly able to answer three simple questions drawn from the New Testament that are keystones of the Christian heritage. Even among teens who attend church regularly (about half of those polled by the Gallup Youth Survey), only 43 percent answered all three questions correctly. One teen-ager in five, 19 percent, was unable to come up with the right answer to any of the quiz questions which were:

1. Can you name the four Gospels of the New Testament of the Bible?
2. How many disciples did Jesus have?
3. What religious event or happening is celebrated on Easter?

□

**CHURCHES, RELIGIOUS GROUPS AFFECTED BY TAX CHANGES.** Three sections of the tax cut package Congress recently sent to President Reagan for his signature contain tax changes of special interest to U.S. religious groups.

The comprehensive tax measure, which will reduce individual and business taxes approximately \$750 billion over the next five years, cleared the Senate on a 67-8 vote and passed the House 282-95.

The final version of the tax cut liberalizes both the amount and scope of the Foreign Earned Income Tax Exclusion. It also reduces the so-called "Marriage penalty tax" and allows a tax deduction for charitable contributions made by persons who elect not to itemize deductions when filing federal income tax forms. For Americans who are "bona fide" residents of foreign countries, Congress agreed to exclude the first \$75,000 income in 1982 and to boost that by \$5,000 annually over the next four years to \$95,000. It also provides for the exclusion of excess housing costs. The new law will replace a variety of deductions and exclusions for Americans working abroad.

Congress also changed the current law under which a married couple with two incomes is taxed at a higher rate than two single persons with identical incomes. To correct this "marriage penalty," the new law allows a couple filing a joint return to deduct 5 percent of the first \$30,000 in earnings of the spouse with the lower income in 1982. The deduction increases to 10 percent of the first \$30,000 in 1983 and the following years, meaning a maximum deduction of \$3,000.

□

**CANADIAN CHURCHES MERGE WITH FREE WILL BAPTISTS.** The National Association of Free Will Baptists welcomed the 16 churches and 1,100 members of Canada's Primitive Baptist Denomination at its 45th annual convention which met July 19-23 in Louisville, Ky., and included over 4,300 delegates and visitors.

The Primitive Baptists, an Arminian group tracing their roots to the northern Free Will Baptist movement fathered by Benjamin Randall in 1780, are based in New Brunswick, Canada. Affiliation with the National Association of Free Will Baptists was proposed a year ago in a feasibility study completed by the Primitive Baptist Executive Committee.

In July, 1981, following a conference with Free Will Baptist Executive Secretary Melvin Worthington, the Canadian churches adopted the Free Will Baptist *Treatise* and petitioned the National Association for membership. National Convention delegates accepted the petition and voted the group into affiliation as the "Atlantic Canada Association of Free Will Baptists."

□

## BIRTHS

to GUY AND KATHY (SANDERSON) ASHTON, Fort Belvoir, Va., a boy, Joshua Ryan, Feb. 17

to EDWIN AND DEBBIE (CORBY) DILCHERD, Nazareth, Pa., a boy, Peter James, Feb. 28

to KEN AND JANET (TASKER) DOUGLASS, Osborne, Kans., a boy, Matthew Kenneth, Apr. 5  
to STEPHEN E. AND SUSAN RAMEY GUNNERSON, Wollaston, Mass., a girl, Suzanne Adkins, June 29

to STEVE AND DEBBIE (FLOYD) JACKSON, Roxana, Ill., a girl, Amanda Gail, March 25

to JOHN H. AND GAYLE JAGERS, Clarksville, Tenn., a boy, Jonathan Larch, June 29

to MYRON AND VIRGINIA (BARR) LEDYARD, Urbana, Ill., a boy, Mark Aaron, June 26

to REV. J. RICHARD AND JUDITH LORD, Monticello, Fla., a girl, Elizabeth Virginia, May 6

to MIKE AND VALERIE (BEELER) MOON, Canon City, Colo., a girl, Jennifer Renee, June 17

to REV. RONALD AND PATRICIA (NIELSON) PARKER, Fawn Grove, Penn., a girl, Meghan Lois, May 3

to TOM AND KAREN READY, Susanville, Calif., a girl, Melissa Jean, May 20

to JERRY AND BETH (WINEBARGER) ROMERO, Susanville, Calif., a girl, Ronda Kathryn, June 19

to REV. BOB AND AMY (COPPLE) RUSSELL, Susanville, Calif., a girl, Sarah Catherine, Feb. 12

to REV. GENE AND TAMRA (KNAPEREK) TANNER, Elkhart, Ind., a boy, Jonathan Gene, June 25

to JERRY AND BETH (HAWKINS) WICKWIRE, Rockdale, Tex., a girl, Sabrina Michelle, Apr. 20

## ADOPTIONS

by RICHARD AND JANE REYNOLDS, Apia, Western Samoa, a girl, Kristen Taua, born March 27, adopted Aug. 10

by GORDON AND JACKIE ZINK, Fritch, Tex., a boy, Aaron Michael, born May 29, adopted July 27

## MARRIAGES

ANN KIEMEL and WILLIAM EARLE ANDERSON II at Boston, Mass., June 7

BRENDA MINGO and REV. JEFFERSON NEWTON in Nassau, Bahamas, July 25

SUE ELLEN EADES and DANIEL L. JENSEN at Union City, Ind., Aug. 1

CATHY LYN FAITH and STEPHEN LEE BUCHANAN at Lubbock, Tex., Aug. 1

SUSAN ELIZABETH TOUSLEY and JOHN MARK MYERS at Columbus, Miss., Aug. 1

SHERYL RICHARDS and DENNIS SEYMORE in Nassau, Bahamas, Aug. 8

REBEKAH PHILENE BOONE and REV. ERNIE LEE ARNOLD, Baton Rouge, La., Aug. 21

SHERILYNN FAY ACHESON and DENNIS A. GOODWIN at Miami, Fla., Aug. 22

FRANCES MARIE RIECK and ARLIE GENE REIMER at Olathe, Kans., Aug. 22

GLENDIA RUTH SHAW and JOSEPH STANLEY NEWSON at Kolapore, Ontario, Aug. 22

## ANNIVERSARIES

MR. AND MRS. FRANK L. DEAN celebrated their golden wedding anniversary July 25. They were married in Rossville, Ga., and have lived

in Jacksonville, Fla., for 39 years. A reception was given for them July 26 at the Jacksonville Oak Hill Church. They have a daughter, Karen Lee and a son, Douglas Allen, both of Nashville.

MR. AND MRS. ELI O. MANGUM of Louisville, Ky., celebrated their golden wedding anniversary on June 14 with an open house given by their children and grandchildren. The Mangums have been Nazarenes for over 40 years, during which time they were members of Nazarene churches in Owensboro, Ky.; Baltimore; Chicago; and Louisville, Ky. They were charter members of the Louisville Hikes Point Church.

Mr. and Mrs. Mangum have two daughters: Mrs. Robert (Beverly) Allen of Louisville, and Mrs. Earl (Joy) Vastbinder of Nashville. They also have four granddaughters.

MR. AND MRS. ARIS WILMOTT McMANUS celebrated their golden wedding anniversary Aug. 22. Aris McManus and Jane Porta Turner were married June 3, 1931, in Nashville. They have two daughters: Janris Wells of Bloomfield Hills, Mich., and Suzanna Hartzler of Columbus, Ohio. The daughters hosted a buffet-reception honoring their parents in the lounge of Nashville First Church.

## DIRECTORIES

**BOARD OF GENERAL SUPERINTENDENTS**—Office: 6401 The Paseo, Kansas City, MO 64131. William M. Greathouse, Chairman; Orville W. Jenkins, Vice-chairman; Jerald D. Johnson, Secretary; V. H. Lewis, Eugene L. Stowe, Charles H. Strickland.

# THE ANSWER

## CORNER

Conducted  
by W. E.  
McCumber,  
Editor

**The "miracles" in the Bible are no more believable than some "far-fetched" incidents in other religions, even ancient religions, so why should we be more inclined to believe them?**

The Bible claims to be a revelation from God, bearing witness to Jesus Christ, through whom God has provided salvation from sin.

The authenticity of Bible miracles and the redemptive work of Christ can be argued by comparison to the writings of those other religions. Ultimately, however, the Word of God is self-authenticating. The Holy Spirit attests to its truth and convinces our hearts. Otherwise, we would not believe, for the natural tendency of sinful hearts is in the direction of unbelief and rebellion. □

**If one refuses the mark of the beast, confesses his sins to God, and accepts martyrdom after the Rapture, will he be saved? I have heard ministers of the gospel say he would be saved, but most of our Bible study group thought he would not. Please help us.**

Since I do not accept the teaching of a pre-tribulation rapture of the church, you may find my answer unsatisfying.

I believe that anyone who repents of sin and believes on Jesus Christ will be saved, whenever and wherever that repentance and faith occur. And I believe the possibility of repenting and believing will exist as long as the Holy Spirit convicts of sin and draws to Christ through the

preaching of the gospel. Until "the day of the Lord," the promise abides, "Whosoever shall call on the name of the Lord shall be saved" (Acts 2:17-21). □

**A Jehovah's Witness cited Leviticus 17:11-14 to support their refusal of blood transfusions. Please comment.**

I think the law given in this passage was (1) hygienic, designed to protect and prolong human life, for animal blood carried diseases and troubled digestion; and (2) symbolic, designed to affirm and illustrate the value of atoning sacrifice, especially the sacrifice of Jesus Christ, whose blood made atonement for our sins.

In neither case does blood transfusion enter the picture. Blood transfusion has saved countless lives. It has nothing to do with animal blood, Mosaic law, or theological symbolism.

I respect the right of those who differ from my opinion to refuse blood transfusions. However, I think it is tragic when they refuse for those who cannot make their own decisions, whose recovery from illness or accident may be negated by such refusals. □

**Is it accurate to say that in justification we experience Christ as Savior, and that in sanctification, we experience Him as Lord?**

I don't think so. Jesus Christ is Lord and Savior of all who are justified by faith in Him. We do experience Him more fully as Lord and Savior when we consecrate our redeemed lives totally to Him and trust Him to cleanse us from all inward sin, and ever more fully as we grow in grace and in knowledge of Him as Lord and Savior. □

# THE CHURCH SCENE



The Porterville, Calif., church Senior Adult Ministry group of 34 escaped tragedy on their way to a three-day retreat in San Diego. Bus driver Dale Phelps, a member of the church, heard a noise from the exhaust system and pulled over to the side of the freeway. He walked to the engine compartment and saw flames flickering above an overheated exhaust pipe. He quickly urged the passengers to get out.

The emergency door was useless since it was directly over the heart of the fire so most of the elderly passengers filed out the front door. A couple climbed out a window. Just moments after all were safely out, flames raged through the floorboards, seats sizzled and smoke blanketed the interior. Though the bus was gutted, luggage stored in the baggage compartment went unscathed.

Some of the passengers' purses, jew-



**NAZARENE PARENTS  
SEEK MISSING DAUGHTER**

The daughter of Mr. and Mrs. Bill Oakes, members of the Lan-

caster, Ky. church, disappeared suddenly October 11, 1980. She has been missing since that day and has not been heard from by any family member or friend.

*Her name and description is:*  
 Helen Marlene Oakes Major  
 Age—26  
 Birthdate—December 7, 1954  
 Height—5'1"  
 Eyes—Green  
 Hair—Blonde  
 Weight—approximately 110 lbs.

Anyone with information about her can contact her parents: Mr. and Mrs. Bill Oakes, 105 Turner Ave., Lancaster, KY 40444. □

elry and handbags were burned. One woman lost a \$500 back brace, and another lost her Bible. But it was evident the Lord was with them.

The bus had just been on a round trip to Seattle, without any problems and recently passed safety inspection. □

## NAZARENE MINISTER IN WESTMINSTER ABBEY SERVICE

Recently, Rev. Glyn Thomas represented the Guide Dogs for the Blind Association in a commemoration service held in Westminster Abbey to

Suddenly your NIV Bible becomes easier to use!

## THE NIV COMPLETE CONCORDANCE

The publication you have been waiting for is **NOW READY!** The complete English concordance to the popular *New International Version*, by Edward W. Goodrick and John R. Kohlenberger III.

- A quarter of a million references cover every major word (and many minor words) in the NIV Bible
- All words are cross-referenced to every spelling variation and variant form.
- Words selected are listed exhaustively and have every occurrence of the word in the NIV listed in its biblical order.
- Every proper name, including each of the names and titles of God, is given with its context.
- Each word is listed under the exact NIV spelling and helps you avoid having to think of the word's dictionary form.



*The Ideal Gift at Christmas!*

With all these benefits **plus** a clear, readable type and first and last words on each page listed at top of the page for faster reference, you'll enjoy topical and word studies as never before. Its completeness is its outstanding feature.

1,044 pages. Brown, hardback, grained cover with full-color jacket. 6" x 9" page size.

Price subject to change without notice

**Only \$19.95**

Helping you find every verse in your *New International Version Bible*

**NOTE:** For a wide selection of NIV Bibles, consult our latest Bibles/Books/Gifts catalog FREE upon request

Available from your

**NAZARENE PUBLISHING HOUSE** • Post Office Box 527, Kansas City, Missouri 64141





The Iowa District selected the pastors' wives as campaign directors in their *Herald of Holiness* drive for 1981. Katy Suman, pastor's wife at Clinton, Ia., First Church accepted the challenge and enlisted the children of the church as her helpers. She named them "Katy's Kids" and promised them a picnic with fun and games if their goal was reached. The children are pictured with a special copy of the *Herald* which they distributed as they made their sales. Renee Runquist, age nine, was top sales-girl. Nora Nippers, age six, did her share, selling when she was in the laundromat one day with her mother. The goal was exceeded and Mrs. Suman received a bag of groceries from the district at the district assembly—thanks to the help of "Katy's Kids."

celebrate the golden jubilee of the association.

Before a packed congregation, Rev. Thomas and his dog Fanta led the procession of clergy from the Jerusalem Chamber Vestry along the Nave to the Quire and Sacarium. Over 600 dogs were present with their owners, and amazingly not a sound was heard from the dogs as the processional hymn commenced with a trumpet fanfare.

The Right Honourable George Thomas, M.P., Speaker of the House of Commons, was the preacher in the service. Later in the day, Rev. Thomas and Mr. G. Thomas met at the tea party held in the Palace Royal Mews.

Rev. and Mrs. Thomas are retired



Rev. Glyn Thomas with his guide dog Fanta, pictured in the forecourt of the First Church of the Nazarene, Dewsbury Road, Leeds, England.

#### MEMO

to church board members:

When you don't pay the electric bill, the lights go out. When you don't pay the fuel bill, there soon will be no means of heating your church. Likewise, if your local church does not pay its Pensions and Benefits Fund in full, you jeopardize the pension and benefits of your present minister, your past ministers, and over 2,000 ministers and widows of ministers who are already retired and depending on the regular church pension check.

Currently ministers may receive up to \$200 a month in the Nazarene "Basic" Pension Program. Since 1919 widows' benefits have been equal to 60 percent of the amount for which their spouse was eligible. With the pension roll now exceeding 2,000 and the total amount of pensions paid out averaging \$250,000 per month, and no General Budget monies allocated for this purpose, one can easily see why full payment of the Pensions and Benefits Fund by each local church is so essential for the fulfillment of this responsibility.

The highest denominational average for district payment of the Fund was 93.38 percent (1978-79 assembly year). This is a commendable achievement, but should the church do less than 100 percent for those who have served the Kingdom and the church so well?

—Pensions and Benefits Services

after many years of successful ministry. However, Brother Thomas recently was involved in a month's ministry in Ulster, Northern Ireland. He is the president of the Torch Fellowship in Leeds, a Christian ministry to the blind. He is a member of the Leeds Dewsbury Church, pastored by Rev. J. R. Wetherill, who accompanied him to London and the Abbey service. □

## Do Your CHRISTMAS SHOPPING



# HERE



### 1982 Bibles, Books, and Gifts Catalog

*Gifts of Christian  
Warmth for All  
Ages and Interests*

Send for your  
**FREE**  
copy **TODAY!**

NAZARENE PUBLISHING HOUSE  
Post Office Box 527, Kansas City, Missouri 64141

## NEW FACULTY JOIN MVNC

Nine new faculty members joined the staff at Mount Vernon Nazarene College this fall. The new faculty members are: Forest Benner, Alan Christman, James D. Dalton, Bud Harbin, Rebecca Hilderbrand, A. Walter Kaufmann, Dennis C. Shaw, Mark R. Stoner, and Robert Tocheff.

Forest Benner is the new part-time professor of religion. Benner comes to MVNC from Olivet Nazarene College, where he taught for 17 years. Benner holds a B.S. from John Hopkins, an S.T.B. from Temple University, a Th.M. from Eastern Baptist Seminary, and a Ph.D. from Temple University.

Alan Christman is the new assistant professor of physical science. He will be responsible for physics. Christman earned master's degrees in mining engineering from Penn State University and West Virginia University.

Dalton joined the faculty as an instructor of business. He will be teaching principles of accounting, intermediate accounting, and Federal Income Tax. Dalton is a 1977 graduate

of Mount Vernon Nazarene, and received his M.B.A. from Avila College in Kansas City.

Bud Harbin joined the faculty as an associate professor of physical education, and will also be the men's varsity basketball coach. Harbin received the B.S. and M.Ed. degrees in physical education from the University of Missouri in 1959 and 1960 respectively. He also has 30 hours of graduate study in counseling.

Rebecca Hilderbrand joined the staff as an instructor in education. Ms. Hilderbrand received her B.S. in education from Eastern Nazarene College in 1977, and earned her M.Ed. in developmental and remedial reading from Penn State University in 1981. She will teach courses such as educational psychology and elementary school curriculum.

Dr. A. Walter Kaufmann is the new professor of mathematics. Dr. Kaufmann holds an A.B. from Greenville College, and earned both his M.A. and Ph.D. from Ohio State University. Dr. Kaufmann comes to MVNC from Roberts Wesleyan College where he

served as academic dean for the past seven years.

Dennis C. Shaw joined the faculty as an assistant professor of science and mathematics. Shaw will be responsible for freshman chemistry and the EGP math program. Shaw earned his M.A. in chemistry from Arizona State University in 1970 and has been teaching at Phoenix Christian High School for the past 14 years.

Mark R. Stoner joined the staff as an instructor of speech communication. Stoner will teach interpersonal communication, group dynamics, public speaking, persuasion, and speech and the classroom teacher. Stoner received his B.S. from Penn State University in 1977 and recently earned his M.A. from Ohio State University.

Robert Tocheff joined the faculty as an instructor in music. He will direct MVNC's Treble Choir and teach piano. Tocheff received his A.A. degree in 1972 from MVNC, and his B.S. from Olivet Nazarene College in 1974. He also earned his M.Ed. in 1978 from Wright State University. □

# TEEN TRAVEL KIT

for an Exciting Mission Tour

Youth Mission Resource Packet 1981-82

It's time to begin! And this kit, especially created for the occasion, will provide your group all the essentials for a rewarding journey.

- 28-Page Illustrated Leader's Guide
- 12 Pressure Fax Masters of Special Information
- 3 Full-color Inspirational Posters
- 1 Colorful 22" x 34" Study Map

Twelve lessons adapted from the adult study book **THE WIND RUNS FREE** to guide youth into awareness of the ministry of Nazarene Missions.

U-4014 ..... \$9.50

Order from your  
**NAZARENE PUBLISHING HOUSE**  
Post Office Box 527, Kansas City, Missouri 64141

Prices subject to change without notice.

# ALL ABOARD!

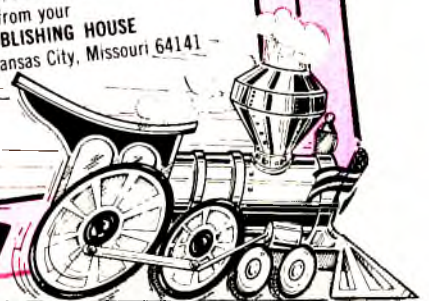

**WALTER CROW ELECTED TO ENBC PRESIDENCY**



Dr. Charles H. Strickland has announced the unanimous election of Rev. Walter Crow as president of European Nazarene Bible College effective January, 1982.

His election came at the annual fall meeting of that institution's Board of Trustees. Walter Crow succeeds Dr. Bennett Dudney who is returning to the U.S. to assume the position of director of Publication Services in the Division of Communications at International Headquarters.

Rev. Crow is currently on assignment in France under the Division of World Mission. He has been serving there since 1979. Prior to his European assignment, he and his wife served as missionaries to Haiti for two terms.

Walter Crow is a graduate of British Isles Nazarene College and Nazarene Theological Seminary. He has done graduate study at Fuller Theological Seminary in Pasadena, Calif. □

—NCN

**NEW INNER-CITY MISSION LAUNCHED IN DOWNTOWN SAN FRANCISCO**

Golden Gate Community, an urban mission in San Francisco patterned after the Lamb's Mission in Times Square, officially began ministry August 1, but is currently in the process of purchasing a building in the Haight-Ashbury area of that city.

According to Rev. Michael Christensen, director of the mission, \$60,000 is needed in cash before October 30 to make a down payment on the \$300,000 structure. The facility will serve as a residency for the staff of five, ministry center, and an initial house of worship.

Golden Gate Community is a district-sponsored project supported by the General Church of the Nazarene.

Rev. Christensen was formerly associate pastor of the Lamb's Mission which he helped pioneer eight years ago.

The new San Francisco ministry will focus on the social and spiritual needs of people in the inner city. According to Christensen, "Haight-Ashbury in the 80s is no longer the hippy haven of the 60s nor the drug ghetto of the 70s,

but is a radically mixed neighborhood of Blacks and Whites, rich and poor, gays and straights, young and old, married and singles, who need to experience the love of God."

Golden Gate Community is an approved 10 percent special project of the Church of the Nazarene and contributions may be sent to Dr. Norman O. Miller, General Treasurer, in Kansas City. □

—NCN

**ADULT MINISTRIES FIELD TESTS FAMILY ENRICHMENT SEMINAR**

The office of Marriage and Family Life recently field-tested a model for family enrichment. The prototype seminar was developed by J. Paul and Marilyn Turner, directors of Marriage and Family Life for Adult Ministries in the Division of Christian Life. The Turners are known throughout the denomination for their development and encouragement of marriage enrichment retreats.

Four basic components form the structure of the Friday evening through Saturday evening format. They are: "We Are Unique," "We Are Friends," "We Talk and Care," and "We Walk Together."

Five sets of parents were involved in this pioneer family enrichment setting. The nine children present, four girls and five boys, ranged in ages from 11 to 17 years. The families are completing an evaluation tool.

According to Turner, the Marriage and Family Life office plans two additional, yet different models. Each one is based on the assumption that participating families are reasonably healthy and committed to spiritual growth. They project completed testing of the concept in mid-1982.

Persons interested in the family enrichment retreat idea may contact the Office of Marriage and Family Life, 6401 The Paseo, Kansas City, MO 64131 (816-333-7000, ext. 364). □

—NCN

**ENROLLMENT AT NIBC CONTINUES TO PRESS CAPACITY TO THE LIMIT**

Enrollment continues at absolute capacity at Nazarene Indian Bible College in Albuquerque, according to President Wayne Stark. In 1980 enrollment took a major leap forward, going from approximately 25 to nearly 50 in the first semester; at one time in the second semester enrollment peaked at 52. First reports of the 1981 fall

enrollment list 47 students enrolled. Among them are representatives of the Navajo, Apache, Mojave, Quechan, Papago, Pima, Eskimo, Chipewa, and Creek tribes.

The school is pressing toward the improvement in facilities and toward Bible college accreditation. When that milestone is achieved, enrollment can be expected to make another major and unprecedented leap.

The Church Extension Office in Kansas City is providing funding for a house trailer, basic equipment for student dormitory rooms, and other equipment needs of more than \$9,000 for which the school is not budgeted. Any special giving above General Budget for the Nazarene Indian Bible College is an approved 10 percent Missionary Special. □

—NCN

**ANNOUNCEMENT**

With the approval of the Board of General Superintendents, and in consultation with the District Advisory Board of the Central Mexico District, I have appointed Rev. Moises Esperilla (now superintendent of Northeast Mexico District) as superintendent of the Central Mexico District, effective immediately.

—Jerald D. Johnson  
General Superintendent

**REZA ELECTED TO PEOPLE-TO-PEOPLE INTERNATIONAL**



Dr. H. T. Reza of Publication Services, Communications Division, was elected member of the Executive Board of People-to-People International at their recent annual meeting in Washington by the Board of Trustees.

People-to-People International was started in 1956 by President Eisenhower when he was in the White House, but since 1961, it has become a private enterprise organization. Dr. Reza has been a member of the Board of Trustees for four years.

People-to-People International sponsors friendly relationships with countries around the world through the Sister Cities program. It also sponsors youth conventions and workshops as well as travel workshops for interested persons. □

# Christmas Beauty

Poinsettias embody the natural beauty of the Christmas season with their brilliant reds and soft whites. The unsurpassed beauty God has placed in these flowers in the middle of winter helps give us faith to believe in the birth of His son. Single fold, 5 designs. Size 4 3/4 x 6 3/4". 15 Cards. **\$3.00**

**G9541**—with Scripture



# Holy Night

The night of Christ's birth brought the first real peace to earth—the peace of His presence. Heirloom nativity figures perfectly capture the aura of that night of nights when the shepherds came and Christ was born. Single fold, 5 designs. Size 4 3/4 x 6 3/4". 15 Cards. **\$3.00**

**G9511**—with Scripture



# Christmas Delites



Bright-eyed children capture the essence of Christmas as they share in giving, singing, providing for others and remembering Jesus whose birthday we celebrate. These charming children will capture your heart. French fold, 5 designs. Size 4 3/4 x 6 3/4". 12 Cards. **\$2.50**

**G9331**—with Scripture

**Order  
AT ONCE!**

Prices subject to change without notice.